

ENVIRONMENTAL HEALTH & SAFETY

UNIVERSITY *of* WASHINGTON

# CONFINED SPACE PROGRAM MANUAL

---

August 2021



## TABLE OF CONTENTS

---

Purpose.....	4
Scope.....	4
Prevent Confined Spaces and Minimize Hazards by Design .....	5
Roles and Responsibilities .....	6
Hazards and Controls in Confined Spaces .....	8
Physical Hazards and Controls.....	9
Fall Hazards .....	10
Hazardous Energy Sources.....	10
Other Physical Hazards .....	12
Atmospheric Hazards and Controls.....	12
Other Hazards and Controls.....	14
Confined Space Evaluation.....	14
Identification of a Confined Space.....	14
Permit-Required Confined Space (PRCS) Determination .....	15
Inventory Permit-Required Confined Spaces .....	16
Inform Employees and Control Entry into PRCS .....	16
Confined Space Entry.....	17
Permit-Required Confined Space Entry .....	17
Alternative Methods .....	18
Communication .....	20
Figure 1: PRCS Entry Process.....	21
PRCS Roles and Responsibilities .....	22
Permit-Required Confined Space (PRCS) Entry Form .....	26
Permit-Required Confined Space (PRCS) Entry Form Instructions.....	27
Ventilation.....	32
General Ventilation .....	32
Local Exhaust.....	34
Purging .....	34
Air Monitoring .....	34

Fall Protection .....	36
Personal Protective Equipment and Tools.....	36
Conclusion of Entry .....	37
Training.....	38
Non-Entry Rescue Practice Sessions.....	39
Frequency .....	39
Documentation .....	39
UW Confined Space Courses .....	39
Rescue and emergency Procedures.....	40
Rescue Services.....	41
Emergency Services.....	41
Rescue Considerations and Types.....	41
Complete Rescue Plan on PRCS Entry Form.....	42
Self-Rescue .....	45
Non-Entry Rescue .....	46
Entry Rescue.....	49
Accident/Incident Reporting.....	50
Contractors.....	50
Audits, Inspections, certifications .....	51
Recordkeeping.....	52
References.....	53
Appendices.....	54
Appendix A: Definitions.....	54
Appendix B: Examples of Confined Spaces .....	61
Appendix C: Confined Space Evaluation Form .....	66
Appendix D: EH&S Approved PRCS Signage .....	68
Appendix E: Permit-Required Confined Space Entry Flow Chart .....	69
Appendix F: Permit-Required Confined Space Entry Form.....	71
Appendix G: Ventilation Practices in Confined Spaces – Effective Positioning of Ventilation Equipment .....	77
Appendix H: Permit-Required Confined Space (PRCS) Rescue Service Evaluation Form .....	85
Appendix I: Equipment for Confined Space Entry and Rescue .....	87

## PURPOSE

---

This document represents the University of Washington (UW) Confined Space Program. The purpose of this program is to ensure personnel safety and prevent personal injury or illness from work in [Confined Spaces \(see Appendix A: Definitions\)](#) according to the requirements of [UW Administrative Policy Statement \(APS\) 10.3](#) and the [Washington Administrative Code \(WAC\) 296-809](#) (Confined Spaces).

The intent of this document is to fulfill the following requirements:

- Develop and enforce a written confined space program.
- Identify confined spaces and determine their hazards.
- Provide guidance on how to eliminate entry into confined spaces, reducing the risk of injury associated with working in confined spaces.
- Identify the necessary steps for entry into [Permit-Required Confined Spaces \(see Appendix A: Definitions\)](#) including assessing physical and atmospheric hazards, methods to eliminate or control the hazards, conducting air monitoring and use and maintenance of equipment that may be required.
- Identify rescue and emergency procedures for confined spaces and the responsibilities of trained employees in such instances.
- Identify training for employees involved with confined space work and identify their duties.
- Provide guidance for managing contractors entering UW owned or leased confined spaces.
- Conduct periodic reviews of individual operations involving permit-required confined spaces and an overall confined space program review.

## SCOPE

---

The UW Confined Space Program applies to all University employees, researchers, students, and contractors who may be required to enter UW owned or leased confined spaces. This includes all locations that serve as assigned workplaces and educational settings for University faculty and staff, including the Seattle, Bothell and Tacoma campuses, the University of Washington Medical Center, Harborview Medical Center, as well as all other University owned properties, University leased spaces, temporary field locations, and research vessels owned or leased by the UW.

The Program also applies to UW employees who may be required to enter confined spaces owned and/or managed by another employer or organization. Entry occurs as soon as any part of the entrant's body breaks the plane of the opening into the space whether or not such action is intentional or any work activities are actually performed in the space.

Excluded from this manual is work related to telecommunications, electrical transmission and distribution.

The Program reflects current regulations. Departments/Units/Organizations must review existing spaces, evaluation records, labeling of spaces, and entry procedures to meet the current requirements in this manual.

*Note: UW departments, units, and organizations can use this Confined Space Program Manual to meet compliance requirements. Departments/units/organizations may develop and require specific procedures, equipment, and documentation for managing their confined spaces. This department/unit/organization-specific information with details may be added as an addendum to this program manual as long as the requirements are equal to or more stringent and do not conflict with the information provided in this document.*

## PREVENT CONFINED SPACES AND MINIMIZE HAZARDS BY DESIGN

---

Although confined spaces typically are not intended for human occupancy, workers must enter them to perform work such as inspection, maintenance, cleaning, and repair. The goal to reduce the risk of working in and around such spaces should be a high priority. Opportunities to not create confined spaces, to eliminate existing confined spaces, and to make existing spaces safer, include:

### **Eliminate the space**

- Avoid creating confined spaces in original building designs and in renovation of existing buildings.
- Provide unrestricted access and egress or multiple access openings.
- Redesign the space for continuous occupancy.
- House equipment in enclosures above ground with standard doorways for access rather than placing in vaults below ground.
- Modify equipment installations inside a confined space to have better access.

### **Eliminate need to enter the space**

- Install critical equipment, valves, and gauges, outside the space that require periodic inspection or maintenance.
- Install viewing and cleaning ports in tanks and equipment so that interiors can be seen and cleaned without entering the space.
- Use remote monitoring devices, drones, cameras, and gas detection systems to monitor equipment.

**Reduce hazards**

- Design the space with adequate platforms and access to equipment.
- Maintain overhead clearance, clear walkways, and wide openings to provide sufficient space to work.
- Install ventilation and lighting in the space.
- Install a fixed ladder where a ladder is needed for entry.

**Facilitate rescue**

- Provide multiple openings to the space at least 24 inches square or 24 inches in diameter (30 inches recommended) for ease of entry and exit with rescue equipment.
- Maintain overhead clearance, clear walkways, and wide openings in the space.

Ensure outside entrance to the space has adequate clearance to set up and execute rescue procedures.

The American Industrial Hygiene Association’s [Prevention through Design: Eliminating Confined Spaces and Minimizing Hazards](#) identifies opportunities for prevention through design. Contact the UW Environmental Health & Safety Department (EH&S) for information on potential solutions and successful examples where design modifications have eliminated confined space hazards.

## ROLES AND RESPONSIBILITIES

Role	Responsibilities
Departments/Units/ Organizations	<ul style="list-style-type: none"> <li>• Provide the necessary resources to implement and maintain the confined space program.</li> <li>• Identify areas at UW owned and leased facilities where there is a confined space and complete the <a href="#">Confined Space Evaluation Form</a>.</li> <li>• Appoint a <a href="#">Competent Person (see Appendix A Definitions)</a> to evaluate confined spaces and determine if they are permit-required confined spaces.</li> <li>• Identify a <a href="#">Confined Space Owner(s) (see Appendix A: Definitions)</a> to ensure that confined spaces are evaluated, labeled, and entry into permit-required confined spaces are in accordance with the requirements in this document.</li> <li>• Maintain an inventory of permit-required confined spaces that are managed by the Department/Unit/Organization.</li> <li>• Label permit-required confined spaces with the appropriate signage, including Confined Space Owner contact information.</li> <li>• Determine the <a href="#">Entry Supervisors, Entrants, and Attendants (see Appendix A: Definitions)</a> within the department and train them on</li> </ul>

	<p>their role, hazards in a permit space, and required Entry Form documentation.</p> <ul style="list-style-type: none"> <li>• Ensure Entrants obtain approval prior to entering a permit-required confined space.</li> <li>• Train all personnel prior to entering permit-required confined spaces.</li> <li>• Ensure all personnel involved in permit-required confined space entries are trained and familiar with non-entry rescue procedures and use of specific equipment for their non-entry rescue practices. Restrict access to permit-required confined spaces by untrained persons.</li> <li>• Understand the contractor requirements of confined space entry.</li> <li>• Report incidents to EH&amp;S.</li> </ul>
<p>Environmental Health &amp; Safety (EH&amp;S)</p>	<ul style="list-style-type: none"> <li>• Assure that a confined space program is established that provides maximum employee protection when employees perform work in permit-required confined spaces.</li> <li>• Produce and maintain program documentation, including a written program, establish program standards, advise departments on compliance, and develop, evaluate, and/or recommend employee training.</li> <li>• Designate a confined space program Administrator who has overall responsibility for the program and has sufficient training or experience with permit-required confined space entry to oversee program development, coordinate implementation, and conduct required evaluations of program effectiveness.</li> <li>• Audit departments for compliance with the program.</li> <li>• Advise and assist departments to fully implement the program for the confined spaces they manage.</li> <li>• Assist departments in evaluating hazardous atmospheres, including consultation and use of specialized equipment for air monitoring and ventilation practices to ensure safe entries.</li> </ul>
<p>Project Managers</p>	<ul style="list-style-type: none"> <li>• Project Managers (hiring managers) of contractors with employees entering UW owned confined spaces must inform contractors of the following:             <ul style="list-style-type: none"> <li>○ Presence of a permit-required confined space that requires completion of a Permit-Required Confined Space Entry Form before entry</li> <li>○ Hazards of the space</li> <li>○ Department/Unit/Organization experience with the space</li> </ul> </li> </ul>

	<ul style="list-style-type: none"><li>○ Precautions and procedures implemented for protecting employees in or around the space</li><li>● Project Managers must ensure that contractors entering UW permit-required confined spaces:<ul style="list-style-type: none"><li>○ Adhere to all applicable regulations regarding confined spaces; inform their sub-contractors or other entities needing entry of any hazards, ensure they are trained to enter, and monitor the entry.</li><li>○ Provide the Project Manager with the company's confined space program for review.</li></ul></li><li>● Project Managers must coordinate with the contractor when employees and employers from different companies are working in or near UW permit-required confined spaces.</li><li>● Project Managers must discuss with contractors, after the entry is completed, the procedures followed and any issues or problems confronted or created during entry.</li><li>● Project Managers must ensure any accidents or incidents related to confined spaces are reported to the UW's <a href="#">Online Accident Reporting System (OARS)</a>.</li></ul>
--	--

[Back to Top](#)

## HAZARDS AND CONTROLS IN CONFINED SPACES

Most accidents in confined spaces happen when workers and untrained rescuers do not recognize hazards in the spaces, or they do not eliminate or control the hazards before they enter. Never assume a confined space is safe to enter. All hazards must be identified and addressed in the planning process prior to entry. Personal protective equipment (PPE) can be used to control exposure if hazards cannot be eliminated or controlled. This is after engineering controls, administrative controls and other control methods have been exhausted. Safe work practices must always be used.

Hazard sources may be directly or indirectly associated with working in and around confined spaces. All potential hazards need to be evaluated as to how it will affect the Entrant's movement in the space, work operations, ventilation, escape, rescue, or firefighting. They include, but are not limited to:

- **Inherent hazards** are permanent properties or attributes of the space, which can include:
  - Limited or restricted access



- Size and shape of the entrance or portal or the space/vessel
- Products or processes that exist in the space that can create hazardous atmospheres or physical hazards (e.g., chemicals, noise, thermal stress, mechanical equipment, etc.)
- Fixed equipment in the space (e.g., piping systems, pressurized lines, conduit, ducts, machinery, etc.)
- Structural integrity of the space (e.g., ladders, flooring, platforms, anchor points, etc.)
- **Introduced hazards** are those hazards not normally associated with the space, but are brought into the space or adjoining space, intentionally or not. These hazards may include:
  - Atmospheric (e.g., contaminated air from external sources), chemical (e.g., cleaning products, painting), hot work (e.g., welding, cutting, burning)
  - Electrical (e.g., equipment not low voltage or intrinsically safe, lighting, power tools)
  - Slip, trip and fall hazards (e.g., ladders, scaffolding used for entry/access inside the space, equipment/tools/cables/ventilation ducts brought into the space)
- **Adjacent hazards** are hazards or conditions that may exist in area(s) surrounding the space, including:
  - Areas that share a common wall or have contact with the space and have possible hazards that may affect the space
  - Nearby work activities that may affect the entry (e.g., pedestrian and vehicle traffic, smoke and exhaust, sparking, heating or cooling or product/material transfers that could impact the adjacent confined space)

## Physical Hazards and Controls

Physical hazards include, but are not limited to, mechanical and electrical hazards, noise, engulfment, falls, wet/slick surfaces, slip/trip hazards, lighting, radiation, vibration, and temperature and pressure extremes. Entrapment hazards are where the shape or configuration of the space itself can exert enough force on the body to cause injury or death by strangulation, constriction, or crushing, and may include narrow cross sections, sloping floors, funneling configurations, or other internal configurations that can entrap. Physical hazards also include fire and explosion hazards created by various chemical agents, such as flammable liquids, paints, solvents, and methane gas, as well as combustible dust (settled and in the air). Common sources of biological hazards include bodily fluids and waste, insect bites or stings, rats, snakes, and microbial pathogens.

## Fall Hazards

To address fall hazards, maintain fall protection for workers and others in and around confined spaces where falls could occur.

- Eliminate fall hazards by covering all vertical entry points until entry.
- Use barriers around the space opening (e.g., guardrails) and around sidewalks or roadways (e.g., fencing or concrete/ecology blocks)
- If a confined space does not have a fixed ladder to enter the space, place and secure a portable ladder for safe entry.

Fall protection must be provided if falls over four feet could occur in the space, such as at floor and wall openings, open-sided platforms and unguarded spaces. Proper fall protection and rescue equipment must be selected and appropriate for use in the confined space.

Factors to consider include:

- The height of potential fall, method of rescue in the event of a fall, and method of entry into the space.
- If standard guardrails do not work in the space, personal positioning/restraint devices and fall arrest systems can be used.
- Some spaces may require Entrants to erect or use scaffolding or climb to a platform or elevated height in the space to do work.
- If the Rescue Plan calls for non-entry rescue in an emergency, the Entrant must wear a fall arrest system for retrieval, which may also serve as a fall protection system if set up as a dual purpose and anchorage system (see Rescue and Emergency Procedures section and the [NFPA 350 Guide for Safe Confined Space Entry and Work](#) for detailed guidance).

Consult the [UW Fall Protection Program Manual](#) for additional information.

Fall hazards	Examples of Controls
<ul style="list-style-type: none"> <li>• Ladder entry, fixed or portable</li> <li>• Hatch/manway</li> <li>• Hole/floor opening</li> <li>• Elevated heights/platforms</li> <li>• Scaffold use</li> <li>• Slip, trip, fall and entanglement hazards</li> </ul>	<ul style="list-style-type: none"> <li>• Guardrails</li> <li>• Cover holes/openings</li> <li>• Personal fall positioning/restraint or arrest systems</li> <li>• Fall protection work plan</li> <li>• Ladder safety device</li> <li>• Ladder safety post</li> </ul>

## Hazardous Energy Sources

Hazardous energy sources from equipment or systems include mechanical, electrical, pneumatic, hydraulic, and gravitational. All of these sources of energy in confined spaces that could impact worker safety should be eliminated using appropriate isolation or equipment-specific lockout/tagout (LOTO) procedures.

Pipes and lines containing gases and liquids that could enter into the confined space must be isolated using the following methods prior to entry:

- Disconnected and drained
- Blanked or blocked
- Double blocked and bleed

Isolating a single valve is not acceptable.

Hazardous Energy	Examples of Controls
<ul style="list-style-type: none"> <li>• Mechanical                             <ul style="list-style-type: none"> <li>○ Moving/rotating parts</li> <li>○ Springs</li> </ul> </li> <li>• Pneumatic                             <ul style="list-style-type: none"> <li>○ Compressor</li> <li>○ Cylinder</li> </ul> </li> <li>• Hydraulic pumps</li> </ul>	<ul style="list-style-type: none"> <li>• Isolate the equipment</li> <li>• Use equipment-specific LOTO procedures</li> <li>• Locks and tags</li> <li>• Blocks</li> <li>• Guards</li> </ul>
<ul style="list-style-type: none"> <li>• Pressurized piping system</li> <li>• Chemical pumps</li> <li>• Thermal                             <ul style="list-style-type: none"> <li>○ Steam line</li> <li>○ Temperature extremes</li> </ul> </li> </ul>	<ul style="list-style-type: none"> <li>• Double block and bleed</li> <li>• Flange</li> <li>• Disconnect</li> <li>• Pin</li> <li>• Use engineering controls</li> </ul>
<ul style="list-style-type: none"> <li>• Gravitational (i.e., heavy objects at high levels with potential to fall on a worker)</li> </ul>	<ul style="list-style-type: none"> <li>• Isolate objects</li> <li>• Secure objects</li> <li>• Control zone underneath</li> </ul>

**Electrical hazards** are a hazardous energy source created by an electrical current, charge, or field capable of causing injury. Consider all electrical sources as a potential hazard, including low-voltage sources (less than 50 volts). Risk related to low-voltage sources may exist due to factors such as wet hands or perspiration that can lower the body's resistance to current flow. Safeguards should address a potentially hazardous current flow. Voltage alone does not determine the severity of electrical shock. The factors that determine the severity of electrical shock are:

- The quantity of current (amperes) flowing through the body
- The path of current through the body
- The amount of time the current flows through the body

All electrical sources in confined spaces that may impact Entrants must be eliminated using appropriate isolation or equipment-specific LOTO procedures. If energized electrical work must be performed in a confined space, a permit-required confined space entry is required.

Electrical hazards	Examples of Controls
<ul style="list-style-type: none"> <li>• Electrical                             <ul style="list-style-type: none"> <li>○ AC</li> <li>○ DC/stored</li> </ul> </li> <li>• Exposed wiring, improper grounding, worn cords, exposed battery terminals</li> </ul>	<ul style="list-style-type: none"> <li>• Use equipment-specific LOTO procedures</li> <li>• De-energize power lines</li> <li>• Energized electrical work plan</li> <li>• Cover or isolate exposed wiring</li> </ul>
<ul style="list-style-type: none"> <li>• Equipment/tools</li> </ul>	<ul style="list-style-type: none"> <li>• Use GFCI in wet/damp or other areas</li> <li>• Use intrinsically safe equipment</li> </ul>

## Other Physical Hazards

**Other physical hazards** may include hazards inherent to the space, introduced or adjacent to the space. Common hazards are listed below with associated controls.

Other physical hazards	Examples of Controls
<ul style="list-style-type: none"> <li>Inadequate lighting, poor visibility</li> </ul>	<ul style="list-style-type: none"> <li>Portable lighting</li> <li>Personal lighting</li> <li>Explosion proof, as needed</li> </ul>
<ul style="list-style-type: none"> <li>Engulfment                             <ul style="list-style-type: none"> <li>Liquid</li> <li>Solid</li> <li>Risk of drowning</li> </ul> </li> </ul>	<ul style="list-style-type: none"> <li>Platform</li> <li>Removal/drain/siphon</li> </ul>
<ul style="list-style-type: none"> <li>Configuration                             <ul style="list-style-type: none"> <li>Entrapment</li> <li>Sloping floor</li> </ul> </li> </ul>	<ul style="list-style-type: none"> <li>Temporary rope/ladder</li> <li>Platform</li> </ul>
<ul style="list-style-type: none"> <li>Falling objects</li> </ul>	<ul style="list-style-type: none"> <li>Remove or secure</li> </ul>
<ul style="list-style-type: none"> <li>Biological agents (viruses, bacteria, fungi, parasites, other living organisms)</li> </ul>	<ul style="list-style-type: none"> <li>Remove</li> <li>Clean and disinfect or sterilize</li> </ul>
<ul style="list-style-type: none"> <li>Sharp objects</li> </ul>	<ul style="list-style-type: none"> <li>Remove or cover</li> </ul>
<ul style="list-style-type: none"> <li>Contaminated surface                             <ul style="list-style-type: none"> <li>Chemical</li> <li>Dust</li> </ul> </li> </ul>	<ul style="list-style-type: none"> <li>Remove or cover</li> <li>Clean and disinfect or sterilize</li> <li>Intrinsically safe vacuum, as needed</li> </ul>
<ul style="list-style-type: none"> <li>Wet environment</li> </ul>	<ul style="list-style-type: none"> <li>Remove moisture</li> </ul>
<ul style="list-style-type: none"> <li>Loose, unstable materials</li> </ul>	<ul style="list-style-type: none"> <li>Remove or secure materials</li> </ul>
<ul style="list-style-type: none"> <li>Radioactive material</li> </ul>	<ul style="list-style-type: none"> <li>Remove</li> <li>Isolate</li> <li>Shield</li> </ul>
<ul style="list-style-type: none"> <li>Noise</li> </ul>	<ul style="list-style-type: none"> <li>Shut down equipment</li> <li>Isolate noise</li> </ul>
<ul style="list-style-type: none"> <li>Vehicle and pedestrian traffic</li> </ul>	<ul style="list-style-type: none"> <li>Barricade/fence</li> <li>Flagger</li> <li>Cones</li> </ul>
<ul style="list-style-type: none"> <li>Sparks and open flame</li> </ul>	<ul style="list-style-type: none"> <li>Remove source</li> </ul>

## Atmospheric Hazards and Controls

Statistics indicate that atmospheric hazards are the most common cause of death in confined spaces. Oxygen deficient and enriched atmospheres are also hazardous. Chemical and atmospheric hazards must be identified by air monitoring from outside the space (described in the Air Monitoring section) and eliminated or controlled before entry.

Oxygen deficiency (less than 20.8%) can be caused by oxygen displacement by other gases and vapors, such as inert gases or evaporating liquids. Oxygen is consumed during rusting of metals (oxidation), combustion processes, normal breathing of workers, decay of organic materials, and by drying of oil-based paints.

Common sources of hazardous atmospheres include airborne chemical hazards (gases, vapors, mists, fumes, liquids, or dusts).

Examples of hazardous atmospheres found in or around confined spaces include carbon monoxide from incomplete combustion (e.g., engines or fires), hydrogen sulfide from decomposing biological material (e.g., rotting fish, seaweed, grains), cleaning operations (e.g., toxic volatile organic compounds, solvents), and welding fumes (e.g., heavy metals). Tanks are especially susceptible to having hazardous atmospheres. Outdoor underground utility vaults and manholes have the potential for a hazardous atmosphere.

Acceptable entry conditions require that the following be controlled to specific levels:

Oxygen levels	19.5% - 23.5%
Lower explosive limit (LEL) of flammable gases and vapors	Less than 10%
Carbon monoxide	Less than 35 ppm
Hydrogen sulfide	Less than 10 ppm
Other air contaminants	Below occupational exposure limits

Natural ventilation alone is often not sufficient to maintain breathable quality air in a confined space. The interior configuration of the confined space may not allow easy movement of air. Methods to remove hazardous atmospheres from confined spaces include forced air ventilation and purging. Forced air ventilation provides breathing quality air to a space and controls contaminants in the space through mixing and dilution. Purging is the use of air, steam, or an inert gas to displace air within the space. Local exhaust ventilation is used to capture and exhaust point source atmospheric contaminants from specific work activities. Additional information is discussed in Ventilation section and [Appendix G: Ventilation Practices in Confined Spaces – Effective Positioning of Ventilation Equipment](#).

Atmospheric hazards	Examples of Controls
<ul style="list-style-type: none"> <li>• Continuous flow system (sanitary sewer or waste)</li> </ul>	<ul style="list-style-type: none"> <li>• Special entry procedures, PPE, respiratory protection</li> </ul>
<ul style="list-style-type: none"> <li>• Oxygen deficient                             <ul style="list-style-type: none"> <li>○ Rust</li> <li>○ Decomposing organic matter</li> </ul> </li> <li>• Fumes/vapors/mists/gases</li> <li>• Flammable/explosive</li> <li>• Dust/particulates</li> <li>• Oxygen enriched</li> <li>• Chemicals</li> <li>• Potential adjacent hazard</li> </ul>	<ul style="list-style-type: none"> <li>• Ventilate with fixed or portable systems/blowers</li> <li>• Purge ventilation</li> <li>• Continuous ventilation</li> <li>• Use non-sparking tools if flammables potentially present</li> </ul>
<ul style="list-style-type: none"> <li>• Introduced hazards (grinding, descaling, painting, welding, etc.)</li> </ul>	<ul style="list-style-type: none"> <li>• Remove the source</li> <li>• Isolate the source</li> <li>• Local exhaust at point source, exhaust to safe place</li> <li>• Hot work permit</li> </ul>

## Other Hazards and Controls

**Psychological and other hazards** can be created in confined spaces where there is restricted movement, excessive noise, PPE restriction or other issues. Some Entrants may easily become claustrophobic or stressed, which may cause them to hyperventilate and alter their ability to reason and make sound decisions. Workers must be trained to be aware of symptoms for their own safety and the safety of coworkers, communicate to the Entry Supervisor, leave the space or do not enter initially, and ask for help if needed.

Psychological/other hazards	Controls
<ul style="list-style-type: none"> <li>• Claustrophobia</li> <li>• Fatigue</li> <li>• Stress</li> <li>• Unsafe behavior</li> </ul>	<ul style="list-style-type: none"> <li>• If entrant shows signs of psychological stress, or unusual behavior they should not enter the space or be removed from the space immediately.</li> </ul>

[Back to Top](#)

## CONFINED SPACE EVALUATION

Each department/unit/organization must identify all permit-required confined spaces at their worksite or where employees may be required to enter to perform work. This may include permit-required confined spaces owned by other employers. A Confined Space Owner, a department or an individual in a department, must be identified for each permit-required confined space. A [Confined Space Evaluation Form \(Appendix C\)](#) must be completed by a Competent Person designated by the Confined Space Owner prior to any entry. Photos of the space or any hazard in the space can also be included on the Confined Space Evaluation Form.

### Identification of a Confined Space

First, determine if the space is considered a confined space:

A confined space is a space that is **all** of the following:

- Large enough and arranged so an employee can fully enter the space and work
- Has limited or restricted entry or exit; for example, tanks, vessels, storage bins, vaults, pits, and excavations are spaces that may have limited means of entry. Access may be via a ladder, manway, access hatch, and/or where the access opening is restricted by piping or other obstructions.
- Is not primarily designed for continuous employee occupancy

Examples of confined spaces at UW may include, but are not limited to:

- Boilers
- Vessels and Tanks
- Storage bins
- Utility vaults
- Sumps and pits
- Sewers
- Attics, plenums and crawlspaces
- Lift stations
- Air handling units
- Cooling towers

- Excavations
- Elevator shafts
- Tunnels and pipelines
- Manholes

Temporary confined spaces may also occur on construction sites. See [Appendix B: Examples of Confined Spaces](#).

## Permit-Required Confined Space (PRCS) Determination

A PRCS is a confined space that has **one or more** of the following actual or potential hazards:

- Contains or has the potential to contain a **hazardous atmosphere**, including:
  - Lack of oxygen that may cause asphyxiation
  - Hazardous air contaminants introduced by activities performed inside the space
    - Chemical use, painting, cleaning, grinding or sanding all create atmospheric hazards (e.g., flammable or toxic atmosphere) that can cause fire/explosion, injury or illness without adequate ventilation or other controls
    - Hot work (e.g., welding, cutting, grinding, or brazing) may release toxic gases or fumes
  - An underground utility vault or manhole because of unknown, potential adjacent hazards from the surroundings
- Contains a liquid or finely divided material that has the potential for **engulfing** an entrant
  - Storage bin or hopper containing grain, sand, soil
  - Water tank
  - Silo containing grain or seed
- Has an internal **configuration** such that an entrant could be trapped or asphyxiated by inwardly converging walls or by a floor, which slopes downward and tapers to a smaller cross-section
  - Hopper
  - Cyclone
- Contains any **physical hazard**
  - Mechanical hazards



Welding in a tank

www.MCAA.org

- Electrical shock
- Equipment with stored energy
- Contains any other recognized serious safety or health hazard that is capable of causing death or serious physical harm
  - Impair the ability to self-rescue
  - Create a situation that presents an immediate danger to life or health

Anyone suspecting that a space meets the definition of a PRCS may not enter the space until it is evaluated and documented.

## Inventory Permit-Required Confined Spaces

Maintain an inventory of the permit-required confined spaces by the department/unit/organization or Confined Space Owner for inspection and audit purposes. Include the following at a minimum:

- Permit-required confined space numbering system
- Campus
- Identifiers (FACNUM, Building, Room Number, description or locating details)
- Hazards
- Controls
- Comments
- Evaluation date
- Alternative method procedures



Permit-required confined space: Part of Van de Graaff accelerator used in nuclear physics and astrophysics research

## Inform Employees and Control Entry into PRCS

If a UW department/unit/organization is responsible for a space that has been evaluated, documented, and verified by a Competent Person to be a permit-required confined space, the UW department/unit/organization and/or the designated Confined Space Owner must do the following:

- Inform affected employees about the existence, location, and danger of any permit-required confined spaces in the workplace and the information and requirements in this Manual.
- Label the spaces with a posted danger sign. See [Appendix D: EH&S Approved PRCS Signage](#). If labeling not possible, use any other equally effective means to inform affected employees of the existence, location, and danger of permit-required confined spaces.



- Secure the entry into permit-required confined spaces to prevent unauthorized employees or persons from entering the spaces. Examples of measures to prevent entry include:
  - Padlocks
  - Bolted covers
  - Use of special tools to remove covers
  - Permanently closing the space entry, such as welding it closed
  - Employee training

[Back to Top](#)

## CONFINED SPACE ENTRY

---

Confined spaces evaluated by a Competent Person that **do not** meet the conditions to be considered a permit-required confined space may be entered without a permit.

Note: At the time of evaluation, no actual or potential hazards were identified in the confined space.

Entries into these confined spaces do not require trained Entrants, Attendants or Entry Supervisors. An employee required to enter a confined space should consult their supervisor or EH&S if they have any concerns regarding their safety or if they have any questions regarding the confined space. Pre-task planning, a Job Hazard Analysis and/or hazard risk assessment could be required for work in confined spaces. Barrier protection for the access portal and minimum personal protective equipment must be identified in the planning process.

Unexpected and potential hazards could be introduced to an identified confined space based on the work performed or changes in space configuration. If either situation arises, the space must be exited and must not be entered until a new Confined Space Evaluation has been completed. See [Confined Space Evaluation](#).



Permit-required confined space:  
Water storage tank

[Back to Top](#)

## PERMIT-REQUIRED CONFINED SPACE ENTRY

---

Confined spaces that contain known or potential safety and health hazards to entrants are known as permit-required confined spaces (PRCS) and require completion and approval of a

PRCS Entry Form to enter. There are two parts to the PRCS Entry Form: Part A and Part B. Part A of the PRCS Entry Form must first be completed. If all hazards are eliminated or controlled, including atmospheric hazards, the Entry Supervisor can approve entry for the Entrant(s) following the requirements outlined in the section below, [Alternative Methods \(see Appendix A: Definitions\)](#). Part B does not need to be completed.

**Important:** Alternative Methods cannot be used for spaces where there are continuous systems (liquid or gas flow) where the space cannot be isolated from the hazards. Under these circumstances, Part B must be completed in addition to Part A of the PRCS Entry Form. Examples of such spaces include lift stations where industrial, sewer, waste, or storm water flow is continuous in the space being entered.

If all hazards cannot be eliminated or controlled and the requirements of Part A of the PRCS Entry Form cannot be met, Part B must be completed in addition to Part A of the PRCS Entry Form. Part B of the PRCS Entry Form includes designation of Attendant(s), evacuation and rescue plans, documentation of air monitoring data as required, and any other controls or procedures to ensure a safe entry. Once all controls are in place, the Entrant and the Attendant(s) must obtain approval from the Entry Supervisor before entering the space. The approved PRCS Entry Form is the “permit” to enter the space.

The figure, tables and forms below provide the following information to help employees understand the permit-required confined space entry process and requirements for safe and successful entries:

- **Figure 1: PRCS Entry Process** is a flow chart that outlines the PRCS entry process and PRCS Entry Form documentation requirements prior to a PRCS entry.
- Tables list details of the **PRCS Roles and Responsibilities** of Entry Supervisor, Entrant and Attendant for confined space entries under PRCS Entry Form Part A (Alternative Methods) and Part B (“permit” entry).
- The **PRCS Entry Form with Instructions** presents the PRCS Entry Form with notes at certain sections to help in completing the form.

An additional flow chart showing the entry process, based on a similar chart in the Confined Space Standard WAC 296-809, is in [Appendix E](#).

## Alternative Methods

Alternative Methods include documentation showing the elimination of any physical and (actual or potential) atmospheric hazards when you have monitoring and inspection data that supports the following:

- You have eliminated all the hazards; or
- You have eliminated all the physical hazards, and continuous forced air ventilation controls the actual or potential hazardous atmosphere. You must also have monitoring data that demonstrates that continuous forced air ventilation will maintain the PRCS safe for entry.

Written documentation must be provided to Entrants before each entry. Use Part A of the PRCs Entry Form or equivalent documentation meeting the requirements of Alternative Methods, which must be signed by the Entry Supervisor before entry.

Before entry, eliminate any unsafe conditions, including removing an entrance cover to a vertical space. When entrance covers are removed, promptly guard the opening with a railing, temporary cover, or other temporary barrier to prevent any accidental falls through the opening and protect Entrants from objects falling into the space.

For spaces with potential atmospheric hazards do **all of the following**:

- Test the atmosphere in the confined space before entry with calibrated, direct-reading instrument for:
  - Oxygen
  - Flammable gases and vapors
  - Carbon monoxide
  - Hydrogen sulfide
  - Other potential toxic air contaminants
- Continuously test the atmosphere in the space when Entrants are present to ensure hazards do not accumulate. Periodically record readings on the PRCs Entry Form Part A or an equivalent form. If Entrants are unable to test and record air monitoring data during their work, Entry Supervisor designates another trained Entrant to test and record air monitoring data.
- Use continuous forced air ventilation as follows:
  - Wait until forced air ventilation has removed any hazardous atmosphere before allowing Entrants into the space.
  - Direct forced air ventilation toward the immediate areas where Entrants are, or will be, working. Continue ventilation until all Entrants leave the space.
  - Provide air supply from a clean source and verify it does not increase hazards in the space.

Evacuate Entrants from the space immediately when any of the following occurs:

- Hazardous atmosphere detected by air monitoring
- Failure of air monitoring instrument
- Failure of ventilation
- A hazard is introduced into the space or develops, or conditions change within the space

After an evacuation, do not reenter space as Alternative Methods until the following is done:

- Correct conditions that caused evacuation.
- Treat any reentry as a new entry.

If an emergency (i.e., a personal medical issue) occurs during an Alternative Methods entry, confirm hazards remain eliminated and/or controlled, evacuate the space, and contact emergency services.

## Communication

Communication is a very important part of reducing hazards in either an alternative methods or permit-required confined space entry. The Entry Supervisor is responsible for communicating the identified hazards, risks, selected controls, and safe work practices to all persons involved with the entry or working near the space. The PRCS Entry Form should outline how communication during the entry, work, and exit stages will be conducted to ensure that Entrants and Attendants can maintain contact during the entry. If voice communication may be hampered by noise, PPE, distance, space configuration, or other blockage, two forms of communications should be used. Communication equipment must be approved, listed and labeled for the classified hazardous atmosphere location in accordance with the National Electrical Code (NEC).

Figure 1: PRCS Entry Process

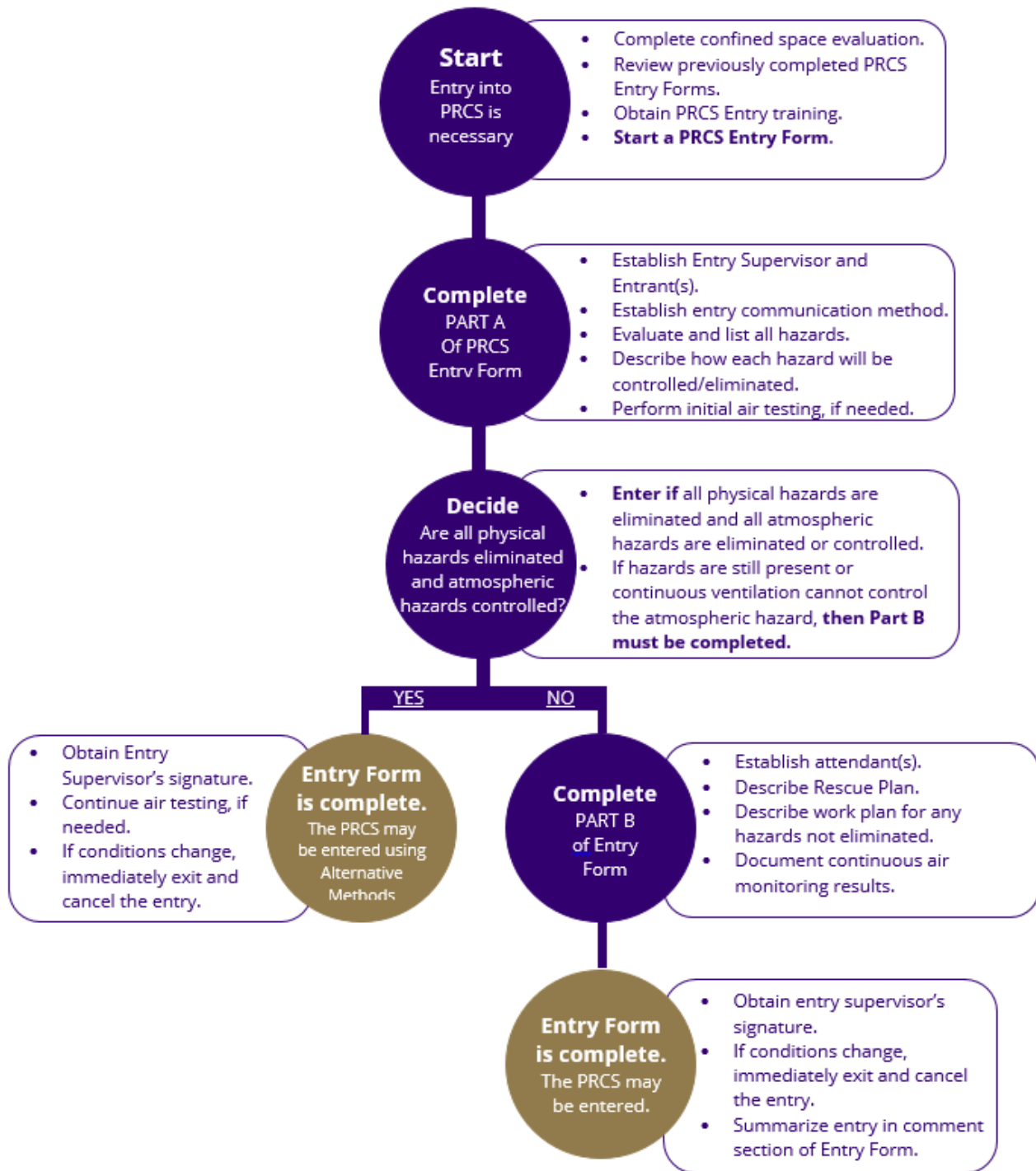

The PRCS Entry Form contains all requirements for entry into a PRCS.

The completed PRCS Entry Form is valid for one day and must be kept on site for the duration of the entry. There are three active roles that trained employees can have during a PRCS entry: Entry Supervisor, Entrant, and Attendant.

## PRCS Roles and Responsibilities

<b>Entry Supervisor</b>		
<b>Responsibility</b>	<b>Permit-Required Space</b>	
	<b>PART A Alternative Methods Entry</b>	<b>PART B Permit- Required Entry</b>
Authorizes the entry into a permit-required confined space by signing the entry permit	X	X
Oversees entry operations	X	X
Successfully completes required training	X	X
Knows the PRCS hazards: <ul style="list-style-type: none"> <li>• Identity of hazardous material contained, or potentially contained, in the space</li> <li>• Mode of exposure (e.g., inhalation or dermal absorption)</li> <li>• Signs or symptoms (including behavioral effects) of exposure</li> <li>• Consequences of exposure to hazards</li> </ul>	X	X
Verifies an Entry Form has been completed that outlines the scope, hazards, and controls of the entry	X	X
Verifies appropriate PRCS pre-job planning has been conducted with operations, maintenance, Entrants, and/or Attendants	X	X
Verifies hazard controls or elimination methods are performed according to all applicable UW EH&S programs (LOTO, Fall Protection, Hot Work, etc.)	X	X
Verifies workers performing atmospheric tests are qualified to conduct testing, that test equipment is within service date, is calibrated, and is properly used	X	X
Requests EH&S assistance for conducting specific atmosphere testing when needed	X	X
Verifies and checks the following: <ul style="list-style-type: none"> <li>• Appropriate entries have been made on the PRCS Entry Form</li> <li>• All tests specified by the Entry Form have been conducted</li> </ul>	X	X

<ul style="list-style-type: none"> <li>All procedures and equipment specified by the Entry Form are in place before approving the permit and allowing entry to the space</li> </ul>		
<p>Verifies:</p> <ul style="list-style-type: none"> <li>Proper non-entry rescue equipment per rescue plan are used when needed</li> <li>Rescue service is available and a means to summon rescue service is in place (confirm the rescue service and select appropriate rescue plan on Entry Form, noting specific phone numbers to call)</li> </ul>		X
Determines number of Attendants needed		X
Verifies that PRCS conditions are acceptable and signs the PRCS Entry Form	X	X
Verifies the PRCS Entry Form is maintained at the job site and any safety data sheets (SDSs) of chemicals in the PRCS and/or used during the entry operation	X	X
Coordinates entries between contractors and UW employees entering a permit space	X	X
Verifies that all other affected employees are aware of PRCS work being performed in their areas	X	X
Ensures that only trained Entrants and Attendants, if required, are in the PRCS work area	X	X
Ensures that responsibility for the PRCS entry supervision remains consistent when there is a change in Entry Supervisors or shifts	X	X
Documents any problems involved with the PRCS entry on the PRCS Entry Form and notifies EH&S of these problems, as needed	X	X
Terminates the entry and cancels the PRCS Entry Form when the work is completed or if a hazardous condition occurs	X	X
Does not serve as an Entrant while an Entry Supervisor, but may serve simultaneously as an Attendant if Part B is required	X	X

<b>Entrant</b>		
<b>Responsibility</b>	<b>Permit-Required Space</b>	
	<b>PART A Alternative Methods Entry</b>	<b>PART B Permit- Required Entry</b>
Successfully completes required training	X	X
Knows the PRCS hazards: <ul style="list-style-type: none"> <li>• Identity of hazardous material contained, or potentially contained, in the space</li> <li>• Mode of exposure (e.g., inhalation or dermal absorption)</li> <li>• Signs or symptoms (including behavioral effects) of exposure</li> <li>• Consequences of exposure to hazards</li> </ul>	X	X
Follows PRCS Entry Form requirements and appropriate confined space entry work practices	X	X
Properly uses the equipment needed for the entry; verifies prior to entry that such equipment is properly functioning and free of defects	X	X
Maintains communication via voice, hand signals, telephone, radio, and/or visual observation with Entry Supervisor and/or Attendant	X	X
Alerts the Entry Supervisor and/or Attendant when: <ul style="list-style-type: none"> <li>• A warning sign or symptom of exposure to a dangerous situation or alarm sounds</li> <li>• A prohibited condition develops</li> <li>• Evacuation of space is necessary</li> </ul>	X	X
Exits the space as soon as possible when one or more of the following occurs: <ul style="list-style-type: none"> <li>• Ordered by the Attendant or Entry Supervisor</li> <li>• Entrant recognizes warning signs or symptoms of exposure</li> <li>• A prohibited condition develops</li> <li>• An alarm (air monitor alarm or building evacuation alarm) is activated that impacts the entrant's safety</li> </ul>	X	X
Does not serve as an Entry Supervisor or an Attendant while an Entrant	X	X



<b>Attendant*</b>		
<b>Responsibility</b>	<b>Permit-Required Space</b>	
	<b>PART A</b> Alternative Methods Entry	<b>PART B</b> Permit- Required Entry
Successfully completes required training		X
While remaining as close as possible, the Attendant cannot enter the PRCS during entry and work operations		X
Knows the PRCS hazards: <ul style="list-style-type: none"> <li>• Identity of hazardous material contained, or potentially contained, in the space</li> <li>• Mode of exposure (e.g., inhalation or dermal absorption)</li> <li>• Signs or symptoms (including behavioral effects) of exposure</li> <li>• Consequences of exposure to hazards</li> </ul>		X
Reviews and verifies all requirements and conditions set on the PRCS Entry Form		X
Ensures that rescue equipment is set up, functional and worn by Entrants as required by the PRCS Entry Form		X
Frequently: <ul style="list-style-type: none"> <li>• Monitors atmospheric sampling instruments, or requests monitor readings from Entrant(s) to ensure atmosphere remains safe</li> <li>• Records test results at least every fifteen minutes on the PRCS Entry Form</li> </ul>		X
Monitors activities inside and outside the permit space to determine if it is safe for Entrants to remain in the space		X
Orders Entrants to evacuate the PRCS immediately when the Attendant: <ul style="list-style-type: none"> <li>• Observes a prohibited condition</li> <li>• Observes behavioral effects of hazardous exposure in an Entrant</li> <li>• Detects a situation outside the space that could endanger the Entrants</li> <li>• Must leave monitoring location or is unable to perform required duties</li> </ul>		X
Keeps safety equipment orderly outside the PRCS		X

Takes the following actions when unauthorized persons approach or enter a space: <ul style="list-style-type: none"> <li>Warns unauthorized persons to stay away from the space</li> <li>Tells the unauthorized persons to exit immediately if they have entered the space</li> <li>Informs entrants and the entry supervisor if unauthorized persons have entered the space</li> </ul>		X
Performs a non-entry rescue, if feasible		X
Summons rescue and other emergency services by the procedure specified on the PRCS Entry Form when Entrants need to be retrieved from the space and receive medical care		X
Performs no duties that interfere with their primary duty to monitor and protect the entrants		X
Monitors entry operations until relieved by another attendant or all entrants are out of the space		X
Entry Supervisor can also serve as an Attendant.		X

\*Note: The role of an Attendant is required only for Part B of the Entry Form.

[Back to Top](#)

## Permit-Required Confined Space (PRCS) Entry Form

Instructions for completing the PRCS Entry Form are on the form. Supplemental instructions with the form are given below. See [Appendix F](#) for the PRCS Entry Form.

# Permit-Required Confined Space (PRCS) Entry Form Instructions

ENVIRONMENTAL HEALTH & SAFETY  
UNIVERSITY of WASHINGTON

Confined Space #: \_\_\_\_\_

## Part A

Trained employee identifies all hazards within the confined space and the controls to eliminate the hazards.

How will Entrant(s) communicate with Entry

Are there fall hazards? If fall hazard greater than 10 feet, complete UW Fall Protection Work Plan prior to entry.

What are hazardous energy sources and controls?

Other physical hazards and controls?

## Permit Required Confined Space (PRCS) Entry Form

(1) Identify all physical and atmospheric hazards in the PRCS. (2) Determine control of hazards through elimination, control, safe work practices, or use of appropriate PPE until hazards addressed. **This PRCS entry permit is valid for one day only.**

General Information		
Date:	Entry Start Time:	Projected Entry Duration:
Department Responsible for Entry:		Purpose of Entry:
Location and Description of Space:		
Entry Supervisor:	Entry Entrant(s):	Is a contractor entering the space? <input type="checkbox"/> Yes <input type="checkbox"/> No <b>Contractor Name</b> _____ <i>I understand the hazards in this space and have current training on my company's Permit Required Confined Space entry program. Contractor Entrant Signature</i> _____
Phone:		
Communication Procedures (include communication equipment, channels, etc.):		

### Part A: Evaluate the hazards present in the permit required confined space

Hazard or Potential Hazard	Hazard Control	Hazard Eliminated?
<b>Physical Hazards</b>		
<input type="checkbox"/> <b>Fall Hazards</b> <b>Related to activities in space:</b> <input type="checkbox"/> 4ft.-10 ft. <input type="checkbox"/> 10 ft.+ <input type="checkbox"/> Hole/Floor Opening <input type="checkbox"/> Elevated Platforms <input type="checkbox"/> Other _____ <b>Related to access into space:</b> <input type="checkbox"/> Hatch/manway <input type="checkbox"/> Ladder Entry (height ____ft.) <input type="checkbox"/> Fixed <input type="checkbox"/> Portable: Type _____	<b>Activities in space:</b> <input type="checkbox"/> Fall Protection Work Plan (attach to Entry Form) <input type="checkbox"/> Personal Fall Restraint <input type="checkbox"/> Personal Fall Arrest <input type="checkbox"/> Other _____ <b>Access into the space:</b> <input type="checkbox"/> Guardrails outside <input type="checkbox"/> Ladder safety system <input type="checkbox"/> Fall arrest system <input type="checkbox"/> Portable ladder entry <input type="checkbox"/> Other _____	<input type="checkbox"/> Yes <input type="checkbox"/> No (Part B required)
<input type="checkbox"/> <b>Hazardous Energy (List all sources)</b> <input type="checkbox"/> Electrical <input type="checkbox"/> AC ____volts <input type="checkbox"/> DC/stored ____volts <input type="checkbox"/> Chemical <input type="checkbox"/> Pumps <input type="checkbox"/> Hydraulic <input type="checkbox"/> Pumps <input type="checkbox"/> Thermal <input type="checkbox"/> Ambient temperature <input type="checkbox"/> Steam line <input type="checkbox"/> Pressurized piping system <input type="checkbox"/> Mechanical <input type="checkbox"/> Moving parts <input type="checkbox"/> Springs <input type="checkbox"/> Pneumatic <input type="checkbox"/> Compressor <input type="checkbox"/> Cylinder <input type="checkbox"/> Gravity <input type="checkbox"/> Other _____	<input type="checkbox"/> Equipment-Specific Lockout/Tagout Procedure (attach to Entry Form) <input type="checkbox"/> Energized Electrical Work Plan (attach to Entry Form) <input type="checkbox"/> Locks and Tags <input type="checkbox"/> Blocks <input type="checkbox"/> Double Block and Bleed <input type="checkbox"/> Flange <input type="checkbox"/> Disconnect <input type="checkbox"/> Pin <input type="checkbox"/> Engineering control: _____ <input type="checkbox"/> Other _____	<input type="checkbox"/> Yes <input type="checkbox"/> No (Part B required)
<input type="checkbox"/> <b>Inadequate Lighting</b>	<input type="checkbox"/> Portable Lighting <input type="checkbox"/> Personal Lighting <input type="checkbox"/> Explosion-proof <input type="checkbox"/> Other _____	<input type="checkbox"/> Yes

ENVIRONMENTAL HEALTH & SAFETY  
UNIVERSITY of WASHINGTON

Confined Space #:

Other physical hazards and controls?

Identify all sources of contaminants that could result in a **hazardous atmosphere**. If a hazard or potential hazard is present, test the air prior to entry, in this order:

- Oxygen (O<sub>2</sub>)
- Lower Explosive Limit (LEL)
- Carbon Monoxide (CO)
- Hydrogen Sulfide (H<sub>2</sub>S)
- Other

Enter

- Ventilation type(s)
- Calculate confined space volume
- Calculate ventilation flow rate needed
- Calculate time to ventilate prior to entry (N/A if fixed ventilation ample)

See [Ventilation](#) section.

<input type="checkbox"/> <b>Engulfment</b> <input type="checkbox"/> Liquid _____ <input type="checkbox"/> Solid _____	<input type="checkbox"/> Platform <input type="checkbox"/> Removal/drain/siphon _____	<input type="checkbox"/> Other _____ <input type="checkbox"/> Yes <input type="checkbox"/> No (Part B required)
<input type="checkbox"/> <b>Configuration</b> <input type="checkbox"/> Entrapment <input type="checkbox"/> Sloping floor	<input type="checkbox"/> Temporary rope/ladder <input type="checkbox"/> Platform	<input type="checkbox"/> Other _____ <input type="checkbox"/> Yes <input type="checkbox"/> No (Part B required)
<input type="checkbox"/> <b>Hazards in space</b> <input type="checkbox"/> Falling objects <input type="checkbox"/> Biological agents <input type="checkbox"/> Sharp objects	<input type="checkbox"/> Contaminated surface <input type="checkbox"/> Wet environment <input type="checkbox"/> Loose, unstable materials <input type="checkbox"/> Radioactive material	<input type="checkbox"/> Noise <input type="checkbox"/> Other _____ <input type="checkbox"/> Removal <input type="checkbox"/> See PPE/Tools below <input type="checkbox"/> Isolate/cover <input type="checkbox"/> Shield
<input type="checkbox"/> <b>Vehicle and pedestrian traffic</b>	<input type="checkbox"/> Clean and disinfect or sterilize <input type="checkbox"/> Other _____	<input type="checkbox"/> Yes <input type="checkbox"/> No (Part B required)
<input type="checkbox"/> <b>Sparks and open flame</b>	<input type="checkbox"/> Barricade/fence <input type="checkbox"/> Cones	<input type="checkbox"/> Flagger <input type="checkbox"/> Other _____ <input type="checkbox"/> Yes <input type="checkbox"/> No (Part B required)
<input type="checkbox"/> <b>Other:</b>	Continue to Part B <input type="checkbox"/> Controls:	<input type="checkbox"/> Yes <input type="checkbox"/> No (Part B required)

Hazard or Potential Hazard	Hazard Control	Hazard Eliminated?
<b>Atmospheric Hazards</b>		
<input type="checkbox"/> Continuous flow system <input type="checkbox"/> Sanitary sewer or waste system <input type="checkbox"/> Oxygen Deficient <input type="checkbox"/> Rust <input type="checkbox"/> Decomposing organic matter <input type="checkbox"/> Fumes/Vapors/Mists/Gases	<input type="checkbox"/> Flammable/Explosive <input type="checkbox"/> Dust/Particulates <input type="checkbox"/> Oxygen Enriched <input type="checkbox"/> Chemical (s): _____ <input type="checkbox"/> Introduced Hazards (grinding, descaling, painting, welding, etc.) _____ <input type="checkbox"/> Underground vault/manhole <input type="checkbox"/> Other: _____	<input type="checkbox"/> Continuous Ventilation <input type="checkbox"/> Fixed <input type="checkbox"/> Portable <input type="checkbox"/> Purge Ventilation <input type="checkbox"/> Isolate source/system <input type="checkbox"/> Local exhaust
<input type="checkbox"/> Yes, can be eliminated <input type="checkbox"/> Yes, can be controlled with continuous ventilation <input type="checkbox"/> No (Part B required)		

**If atmospheric hazards or potential atmospheric hazards are present, Ventilation and Atmospheric Testing sections are REQUIRED.**

Ventilation					
Specify the type of ventilation used: <input type="checkbox"/> Fixed <input type="checkbox"/> Portable	Volume of space (L x W x H in cubic feet) = Air changes = 20 (per hour) Ventilation Rate (CFM) =	Amount of time (minutes) need to ventilate prior to Entry = Volume of space (Cubic Feet) x 20 Air Changes ÷ Flow Rate (CFM)			
<input type="checkbox"/> N/A					
Atmospheric Testing					
Substance Monitored:	Permissible Levels:	Initial test Time/ Results	Time/Results	Time/Results	Time/Results
Oxygen (O <sub>2</sub> ) levels	19.5% - 23.5%				
Lower Explosive Limit (LEL)	<10%				
Carbon Monoxide (CO)	<35 ppm				
Hydrogen Sulfide (H <sub>2</sub> S)	<10 ppm				
Other:					

Revised August 2021

ENVIRONMENTAL HEALTH & SAFETY  
UNIVERSITY of WASHINGTON

Confined Space #:

Enter PPE and tools required if not part of pre-task work plan.

If all physical hazards can be eliminated from the space, and all atmospheric hazards can be eliminated, or controlled with continuous ventilation, you can enter using [Alternative Methods](#). The Entry Supervisor signs the bottom section of Part A. Part B of the PRCS Entry Form is not required.

Note: During Alternative Methods entry with continuous ventilation, periodic air monitoring checks can be recorded in the atmospheric monitoring section on page 2 of form above.

List all instrumentation for Atmospheric Testing and/or Monitoring			
Instrument name	Model number:	Last Calibration Date:	Bump test
			<input type="checkbox"/> Pass
			<input type="checkbox"/> Pass
			<input type="checkbox"/> Pass

PPE /Tools Required	Type of PPE/Tools	PPE /Tools Required	Type of PPE/Tools
<input type="checkbox"/> Gloves		<input type="checkbox"/> Tool belt	
<input type="checkbox"/> Personal Fall Protection		<input type="checkbox"/> Volt meter	
<input type="checkbox"/> Coveralls (Tyvek)		<input type="checkbox"/> Respirator & cartridge	
<input type="checkbox"/> Safety Glasses		<input type="checkbox"/> Hearing Protection	
<input type="checkbox"/> Goggles		<input type="checkbox"/> FPR Clothing (Arc Flash)	
<input type="checkbox"/> Face Shield		<input type="checkbox"/> Non-sparking tools	
<input type="checkbox"/> Bump cap/Hard Hat		<input type="checkbox"/> Other:	
<b>All PPE/Tools inspected before use? <input type="checkbox"/> Yes <input type="checkbox"/> No</b>			

List optional controls (e.g. attendant):

*If all physical hazards are eliminated from the space, and all atmospheric hazards are eliminated or controlled with continuous ventilation, Entrant(s) can enter with Alternative Methods. Are all physical and atmospheric hazards controlled or eliminated?*  YES  NO

**If YES, Entry Supervisor signs below and entrant(s) move forward with entry procedure. If NO, complete Part B.**

Entry Supervisor Signature:

Post Entry Notes about the space & entry (including whether evacuation was necessary):

**Entrant(s) maintain completed Entry Form and any SDSs for chemicals used or present in the space. If hazardous condition or atmosphere is created, the Entrant(s) must exit the space and notify the Entry Supervisor.**

**Retain completed Entry Form for 1 year after entry.**

This is the end of Part A.

**Part B**

Identify the hazards not eliminated in Part A. List a hazard control for each hazard identified.

Attendant(s) required for PRCS entry.

Describe the [Rescue plan](#) developed under [Emergency Procedures and Rescue Services](#).

**Part B: Complete information for all hazards not eliminated/controlled in Part A**

Hazards still present (not eliminated in Part A)	Plan to control or mitigate existing hazards during entry

Establish Attendant(s): Name(s): \_\_\_\_\_

**Rescue Plan: Select option that applies or describe plan AND complete contact information.**

Option #	Hazard Scenario (all must apply)	Rescue Requirements	Contact Information
<input type="checkbox"/> Option 1 (baseline)	<ul style="list-style-type: none"> <li>Non-time sensitive hazard</li> <li>Unrestricted access, no obstacles in space, no hazardous atmosphere</li> </ul>	<ul style="list-style-type: none"> <li>Non-entry rescue</li> <li>Entry rescue service with extraction capability</li> <li>Rescue Evaluation &amp; Agreement in place</li> <li>Confirm available rescue service and, if needed, emergency service</li> </ul>	<input type="checkbox"/> Rescue service contacted Rescue service: Phone number: <input type="checkbox"/> Emergency service Emergency service: Phone number:
<input type="checkbox"/> Option 2	<ul style="list-style-type: none"> <li>Non-time sensitive hazard</li> <li>Non-entry rescue not feasible</li> </ul>	<ul style="list-style-type: none"> <li>Entry rescue service with extraction capability</li> <li>Rescue Evaluation &amp; Agreement in place</li> <li>Confirm available rescue service and, if needed, emergency service</li> </ul>	<input type="checkbox"/> Rescue service contacted Rescue service: Phone number: <input type="checkbox"/> Emergency service Emergency service: Phone number:
<input type="checkbox"/> Option 3	<ul style="list-style-type: none"> <li>Severe hazards</li> <li>Time sensitive rescue response needed (e.g. IDLH atmosphere, fall from great height, etc.)</li> </ul>	<ul style="list-style-type: none"> <li>On-site entry rescue service at PRCS</li> <li>Non-entry rescue, if feasible</li> <li>Rescue Evaluation &amp; Agreement in place</li> <li>If needed, confirm available emergency service</li> </ul>	<input type="checkbox"/> Rescue service on-site at PRCS Rescue service: Phone number: <input type="checkbox"/> Emergency service Emergency service: Phone number:

If atmospheric/potential atmospheric hazards are present, atmospheric monitoring (next page) is required before and during entry.

**Entrant(s) maintain completed Entry Form and any SDSs for chemicals used or present in the space. Retain completed Entry Form for 1 year after entry.**

Once all controls are in place, **obtain Entry Supervisor's signature before entering the confined space.** This Entry Form is the "Permit" to enter the PRCS.

<b>Approval for Entry</b>	Entry Supervisor's Signature: _____
<b>Entry Completion &amp; Review</b>	Entry End Time: _____ <b>Post Entry Notes</b> , comments, problems during entry (if evacuation was necessary), and contractor touch base: _____

Once all controls identified are in place, the Entrant and Attendant obtain Entry Supervisor's signature before entering the PRCS. The PRCS Entry Form must be kept on-site for duration of entry.

Revised August 2021



## Ventilation

If a confined space contains an atmosphere that is oxygen deficient, flammable, contaminated with a hazardous gas, chemical or material, or considered immediately dangerous to life or health (IDLH), the space will require ventilation. Ventilation is also used to provide thermal comfort for entrants working in the space.

A qualified person (e.g., entry supervisor) must determine the method of ventilation based on the confined space configuration, the types and concentrations of contaminants, the volume and placement of the supply air and the exhaust locations.

The types of ventilation typically used to provide breathing quality air in confined spaces are general (dilution) and local exhaust ventilation.

A third, less common method of ventilation is Purging. It is often used to remove a flammable or combustible atmosphere by purging the space with an inert gas to remove the flammability hazard, followed by ventilation with breathing quality air prior to entry.

### General Ventilation

General ventilation is the most common method of ventilation used in a confined space entry. General ventilation supplies large volumes of breathing quality air (fresh air) into the space to dilute the contaminants to concentrations that are no longer hazardous. General ventilation methods are ideal for controlling low concentrations of a hazardous atmosphere.

When using general ventilation, air monitoring must still be conducted to determine the air quality in the space. General ventilation may not effectively dilute contaminants during certain activities (such as painting and welding) and is not recommended for highly toxic atmospheres. Local exhaust ventilation is more appropriate in these situations, and can be used in addition to general ventilation.

General ventilation may be from multiple sources, including permanently installed ventilation equipment in the confined space, part of a building ventilation system, and portable blowers and/or exhausters with ducting set up to force ventilation supply air into the space and/or exhaust air from the space for the specific entry.

Forcing ventilation into the confined space is more effective than pulling air from the space, but the pull method may be useful in spaces where there is one entrance/exit and the gases or vapors are heavier than air and settle at lower levels. An evaluation of the supply air source is required if using the pull method to ensure the air is of breathing air quality.

A combination of pushing air and pulling air from the space may be useful for long horizontal confined spaces that have multiple entrance/exits in order to ensure effective ventilation and removal of contaminants.

The location of the blower ducting inlet/outlet should be placed to optimize the mixing effectiveness of the air within the space, removal of contaminants and provide good quality breathing air and cooling comfort to the entrants.



For more information and illustrations of ventilation practices, see [Appendix G: Ventilation Practices in Confined Spaces – Proper Positioning of Ventilation Equipment](#).

Professional organizations recommend that ventilation in a confined space be 20 air changes per hour (ACH) to clear minor contaminants, and provide fresh air and comfort to entrants. To achieve 20 ACH a blower or ventilation device of sufficient capacity must be selected based on the size of the space, and taking into consideration the reduction in flow based on the diameter and length of the ducting and the number of 90° bends in the ducting to ventilate the space. This information should be available on the blower manufacturer specification sheet.

The minimum amount of blower air flow (CFM or cubic feet per minute) for a specific space is calculated as follows:

$\frac{\text{Volume of Space } \underline{\hspace{2cm}} \text{ cubic feet}}{60 \text{ minutes/hr.}} \times 20 \text{ air changes/hr.} = \frac{\text{Ventilation device minimum flow rate}}{\underline{\hspace{2cm}}} \text{ CFM}$
---

The calculation below is performed to determine the minimum amount of time needed to ventilate a space before it could be considered safe to enter. Clean air, at least 20 times the volume of the space, is ventilated into the space to purge the atmosphere. This is based on the American Industrial Hygiene Association (AIHA) recommendation of 20 air changes per hour. The following parameters must be known:

- Volume of space (cubic feet)
- Ventilation device flow rate (CFM or cubic feet/minute)

To determine the minimum time the ventilator or blower should operate before testing the air prior to entry, divide the volume of the space by the flow rate of the blower. Multiply that by the number of air changes required. If the time calculated is more than 60 minutes, the ventilation device flow rate is not high enough to achieve 20 ACH in the space. A blower with a higher flow rate should be used. If fixed ventilation in the space alone is sufficient to achieve 20 ACH in the space, calculating the time before entry is not applicable. Document ventilation information and calculations on Part A of the PRCS Entry Form.

Continue to ventilate the space at a rate of 20 air changes per hour as needed.

$\frac{\text{Volume of Space } \underline{\hspace{2cm}} \text{ cubic feet}}{\text{Ventilation device flow rate } \underline{\hspace{2cm}} \text{ CFM}} \times 20 \text{ (\# of air changes)} = \underline{\hspace{2cm}} \text{ minutes}$
--

Ensure that ventilation supply air is drawn from a clean breathing quality air source.

## Local Exhaust

Local exhaust is ideal for flammable and toxic materials that are produced at a single point, or for hazards that are introduced into the space, such as in welding, hot work, and painting. Air contaminants are captured close to the source of contamination and removed from the space. The local exhaust system should be evaluated to ensure the system has been designed for the removal of the contaminants. Specific recommendations based on best practices include:

- The capture velocity at the task that requires local exhaust ventilation should be at least 100 feet per minute (fpm).
- The exhaust duct should not be more than 1.5 duct diameters in distance away from the work.
- The exhaust duct should be placed so it does not draw contaminants across the worker's breathing zone.

Local exhaust is not ideal when the contamination is widely spread around the space. Exhaust air must be discharged away from the space without creating a hazardous environment. Local exhaust does not replace general ventilation. General ventilation and local exhaust can be used at the same time.

## Purging

Purging is the use of air, steam, or an inert gas to displace air within the confined space and achieve safe atmospheric levels in the space. Purging can eliminate atmospheric hazards for the entry if there is no potential for formation of an atmospheric hazard during the entry. "Inerting" is a special form of purging that involves purging oxygen from a confined space using an inert gas (such as nitrogen, carbon dioxide, or argon) to remove the hazard of fire or explosion. Since purging with an inert gas creates a hazardous atmosphere, it is not allowed without prior approval from EH&S and management. When an inert gas is used to displace flammable vapors in a space, it needs to be introduced and maintained until flammable vapor concentration has been reduced to a safe level. Then fresh air is introduced to displace the remaining flammable vapors and increase the oxygen content to normal ambient fresh air levels. See the *NFPA 350 Guide for Safe Confined Space Entry and Work* for detailed guidance.

## Air Monitoring

Air monitoring is required if an actual or potential hazardous atmosphere may exist or occur in a confined space during entry. Before entry, a person trained in air monitoring must test for hazardous atmospheres in the space. This person should have the knowledge and skills to understand the test instrument's use, limitations, and calibration procedures. This person must understand effective monitoring techniques and have the ability to interpret results.



www.OSHA.gov  
Conducting air monitoring  
in a confined space

Test the air initially as described below and document in Part A of the PRCS Entry Form.

A hazardous atmosphere must be eliminated or controlled before entry. If Alternative Methods are used to enter the space and forced air ventilation is used to control atmospheric hazards, conduct air monitoring throughout the entry and record results periodically in Part A of the PRCS Entry Form.

If Alternative Methods cannot be used to eliminate or control potential or existing atmospheric hazards or the entire confined space air quality cannot be determined, continuous forced air ventilation and continuous air monitoring is required in accordance with all of the requirements of Part B of the PRCS Entry Form. All air monitoring results must be documented in Part B of the PRCS Entry Form, prior to entry and every 15 minutes during the entry.

Air monitoring for levels of oxygen, lower explosive limit (LEL) for flammable atmospheres, carbon monoxide, hydrogen sulfide, and other air contaminants must be tested in the order below and fall within the regulatory limits (Table 1).

Table 1: Regulatory Limits for Hazardous Atmospheres

Hazard	Regulatory Limit <sup>1</sup>
Oxygen (O <sub>2</sub> )	19.5 – 23.5 %
Lower Explosive Limit (LEL)	< 10 % <sup>2</sup>
Carbon Monoxide (CO)	< 35 ppm <sup>3</sup>
Hydrogen Sulfide (H <sub>2</sub> S)	< 10 ppm
Other Contaminants	PEL <sup>4</sup> , STEL <sup>4</sup> , TLV <sup>5</sup>

Notes:

1. As assigned by the Washington State Department of Labor and Industries, Airborne Contaminants WAC 296-841.
2. < = less than
3. ppm = parts per million.
4. PEL = personal exposure limit, STEL = short term exposure limit (regulatory limits)
5. TLV = threshold limit value (advisory limit)

Atmospheres above 50% LEL must NOT be ventilated due to explosion hazard. **CALL 9-1-1 IMMEDIATELY** and then contact EH&S if air monitoring results indicate that an atmosphere is above 50% LEL. At no time must an Entrant enter a PRCS where airborne concentrations exceed the regulatory limits or UW requirements without management approval. Enrollment in the [UW Respiratory Protection Program](#) is required if respirators need to be worn.

Air monitoring test equipment must have a current calibration sticker, and a person trained on the use of the specific air monitoring equipment must perform a [Bump Test \(see Appendix A: Definitions\)](#). The Bump Test (a qualitative function test with challenge gases at concentrations that will activate the alarms) confirms that the sensors and alarms will respond to the target gases, and should be performed before each day's use. Consult the monitor manufacturer's instructions manual for information regarding type/mixture/concentrations of gases needed for a Bump Test. If the monitor fails to respond normally, it must be recalibrated or taken out of service. A bump test does not calibrate the sensors.

Air monitoring inside the space must be performed from outside of the space using a long sampling line or probe. Monitor every four feet vertically, starting at the top of the space through to the bottom of the space, as gases may settle into layers. The sampling line must be able to reach a few inches from the bottom of the space. The minimum sampling time must be in accordance with the manufacturer's instruction manual with additional time added to accommodate the length of the sampling line and flow rate.

For horizontal confined spaces, a supported line or probe can be used. Measurements should be taken every four feet in front and to the sides of a person when moving through the space where it has not been tested.

Continuous air monitoring should be done if the atmosphere can change, such as during welding, painting, descaling, cleaning with chemicals, or working in sewers. A secondary monitor may be worn by the Entrant as an added precaution.

Initial air monitoring requirements apply to any reentry of the space after any break.

Each department is responsible for their air monitoring equipment, calibration and maintenance.

## Fall Protection

Fall protection needs must be determined in planning for an Entry. Fall protection is required for fall hazards of four feet or more. Any time the entrance cover or access door is opened for preliminary inspection, conducting air monitoring, ventilating the space with blowers and ducting, or other activity, fall protection may be required for the person doing the work near a fall hazard. This may include setting up guardrails around the entry or using a personal fall restraint or arrest system tied to an anchor.

Even in an Alternative Entry, fall protection may be required. Rescue type equipment (i.e., tripod system) may be used to provide an anchor to address fall protection needs for Entrant(s), such as backup fall protection required when entering a space by a fixed ladder that is 24 feet long or greater.

For more information, refer to [Appendix I: Equipment for Confined Space Entry and Rescue](#) and the [UW Fall Protection Program Manual](#).

## Personal Protective Equipment and Tools

All employees must wear certain personal protective equipment (PPE) as determined by an exposure assessment, Job Hazard Analysis (JHA) or standard operating procedure (SOP). For entry into a permit-required confined space, the selected PPE must be clearly defined in the Permit-Required Confined Space Entry Form. The proper level of protection depends on the task and tools used to perform the task in the specific confined space. If applicable airborne contaminant exposure monitoring data is available, the level of PPE should reflect the expected level of exposure. If data is not available for a specific task, air monitoring should be conducted as discussed in the Air Monitoring section of this document.

PPE and tools may include, but are not limited to, the following:

- Safety goggles/glasses
- Disposable gloves
- Face shield
- Disposable hoods
- Disposable coveralls
- Flame resistant or arc flash clothing
- Ear plugs, ear muffs
- Hard hat/Bump cap
- Shoe covers
- Tool belt
- Volt meter
- Communication equipment
- Respirator/cartridges
  - Half-face
  - Full-face
  - PAPR
  - N95

PPE must be inspected before each use. All personnel must be trained in the proper use, care and limitations of the PPE required to be worn during a confined space entry.

Where atmospheric exposures cannot be adequately controlled by engineering or other controls, respirators must be used. Employees who are required to wear respirators must obtain medical clearance, attend annual respiratory protection training and be fit tested annually for a specific respirator as required by the [UW Respiratory Protection Program](#) prior to using a respirator.

For more information on personal protective equipment, see the [Guidelines for Personal Protective Equipment](#) on the EH&S website.

## Conclusion of Entry

Upon conclusion of the entry operations, the Entry Supervisor is responsible for terminating the entry and must complete the “entry completion and review box” on Part B of the PRCS Entry Form. Any problems encountered during the entry operation must be noted on the form. When a condition exists that is not acceptable, the Entry Supervisor is also required to terminate the entry (order the stopping of work and exiting of the space) and complete the PRCS Entry Form noting reasons for early termination of the entry. If the listed rescue service becomes unavailable during the course of the entry, the Entry Supervisor must terminate the entry and complete the PRCS Entry Form immediately.

Entry must not exceed the entry duration listed on the PRCS Entry Form or 8 hours.

When scheduled work operations in a PRCS have concluded:

1. Entrants will exit the space.
2. The area will be closed off.
3. The PRCS Entry Form will be cancelled by the Entry Supervisor.

[Back to Top](#)

## TRAINING

---

Training is required for everyone involved in planning, supervising, entering or participating in confined space entry and rescue. Employees required to work in a PRCS must receive training:

- Before they are first assigned to duties in a PRCS
- Before there is a change in employee's assigned duties in a PRCS
- When there is a new PRCS hazard that the employee has not been trained on
- When retraining is needed to reinforce confined space knowledge and procedures

EH&S provides instructor-led training at the Seattle campus to employees working as Entry Supervisors, Entrants, and Attendants for safe performance of assigned duties in PRCS areas. For UW personnel at other UW locations, EH&S will support the organization's development and/or review of confined space training if attending the EH&S-supported training is not possible.

Trainees must demonstrate proficiency in the tasks required before the training is complete. Supplemental training and refresher training is required when changes occur in procedures, conditions or equipment; or to increase and reinforce employee knowledge.

PRCS training is not required of employees entering a confined space that is not a PRCS; however, online [Confined Space Entry Awareness](#) training is available from EH&S to make employees aware of potential hazards associated with confined spaces. Additionally, personnel working in locations adjacent to confined spaces may benefit from taking this online course to understand the hazards associated with working in confined spaces.

Training topics for Permit-Required Confined Space Entry include, but are not limited to:

- Confined space regulations and definitions
- Confined space entry hazards
- Roles and responsibilities of Entry Supervisor, Entrant, and Attendant
- Identification of potential hazards (e.g., chemical or physical)
- Introducing hazards (e.g., hot work, painting, etc.)
- Symptoms of exposure to potential hazards
- Methods used to isolate, eliminate and control hazards
- Safety equipment use and maintenance
- PRCS Entry Form procedures
- Entry and exit procedures
- Entry using Alternative Methods
- Ventilation/purging
- Air monitoring (instrumentation use and calibration; evaluation of air monitoring results)

- PPE selection, proper use, inspection, maintenance, and limitations
- Emergency procedures, rescue plan, evacuation, non-entry rescue, rescue services, and emergency services
- Dangers of attempting unauthorized rescue

Certify\* employee proficiency in their assigned duties by any of the following:

- Trainer observes employee performance using safe work procedures and equipment to perform specific job tasks during training exercises that simulate actual confined space conditions
- Comprehensive written exam
- Any other effective method

\*Certification documents each employee's name, trainer's written or electronic signature or initials, and dates of training

## Non-Entry Rescue Practice Sessions

Departments should conduct PRCS non-entry rescue practice sessions periodically with their own equipment in their own PRCS's or representative spaces. Additional rescue and emergency procedure requirements are described in the section below, [Emergency Procedures and Rescue Services](#).

## Frequency

Entry Supervisors, Attendants, and Entrants must receive training before the first assignment of work in a PRCS. Employees must receive periodic refresher training and additional training anytime there is a change in assignment, operation, or procedures, or when there has been an incident.

## Documentation

All confined space training will be documented with the date of training and a listing of trainees and kept on file by the department and EH&S. Follow the appropriate [records retention schedule](#).

## UW Confined Space Courses

**Permit-Required Confined Space Entry** – 12 hours, instructor-led course

*Prerequisites:* Fall Protection training within the last 3 years. Other prerequisites may include Hazardous Energy Control, Respiratory Protection, Electrical Safety, and others depending on the hazards present.

This classroom and hands-on training course teaches how to plan and safely conduct an entry into a PRCS. This course will qualify and train PRCS Entry Supervisors, Attendants and Entrants to conduct a PRCS entry. This course covers proper use and limitations of air monitoring equipment such that the Attendant can use required

equipment. You will learn how to evaluate, test, and control potential hazards, identify participants, set up equipment, and complete a PRCs Entry Form. This course requires an exam plus demonstration of understanding of confined space entry requirements. All employees who enter permit-required confined spaces must take this instructor-led training described on the [EH&S website](#) or an approved equivalent course.

**Permit-Required Confined Space Entry Refresher** – 2 hour, instructor-led course

*Prerequisite:* Confined Space Entry 12-hour course

This hands-on refresher course covers the hazards and safety precautions associated with entering and working in PRCs. Emphasis is on hazard assessment, planning, air monitoring, safety equipment, gear, and non-entry rescue. Students will complete a PRCs Entry Form and practice an entry. Hard hat, safety glasses, safety vest, and work shoes are required. Use as a refresher or as determined by supervisor based on employee skills and competency.

**Confined Space Entry for Researchers & Academics** – 45 minutes, online course under development

*Prerequisite:* Confined Space Entry Awareness

Designed for researchers and academics, this course covers examples of confined spaces that may need to be entered while performing work-related activities. This course discusses permit-required confined spaces that may be entered using Alternative Methods. The course reviews Part A of the PRCs Entry Form. For spaces where hazards cannot be eliminated prior to entry, the Permit-Required Confined Space Entry course is required. Consult EH&S for hazard evaluation and entry work plan review.

**Confined Space Entry Awareness** – 30 minutes, online course

*Prerequisite:* None

This is an awareness-level course and the online content does not certify an employee to enter permit-required confined spaces.

[Back to Top](#)

## RESCUE AND EMERGENCY PROCEDURES

---

Note: This section is not applicable when all hazards in a PRCs have been eliminated or controlled and entry can be conducted using Alternative Methods. The Entry Supervisor must sign Part A of the Entry Form approving the entry. If an emergency (i.e., a personal medical issue) occurs during an Alternative Methods entry, confirm hazards remain eliminated and/or controlled, evacuate the space, and contact emergency services.

If all hazards cannot be eliminated or controlled, Part B of the Entry Form must be completed in addition to Part A. In planning for the PRCs Entry, develop and document a **Rescue Plan** in Part B of the Entry Form to:



- Safely remove injured Entrant(s) from the space, and
- Provide care for injured Entrant(s) after removal from the space

A rescue plan is activated if an event in or near the PRCS endangers Entrants.

## Rescue Services

Rescue services for confined spaces must be specially qualified, trained, and equipped personnel to enter and remove Entrants from confined spaces. This could be a special unit within a local fire department or a third party company. The UW does not have a confined space rescue team. To meet regulations, the UW unit or department/Confined Space Owner/Entry Supervisor must:

- Evaluate rescue services to determine qualified providers that can perform rescues in the specific UW confined spaces. Use the [Permit-Required Confined Space Rescue Service Evaluation Form \(Appendix H\)](#).
- Ensure that the unit or department has an agreement with a qualified rescue service to provide the rescue services.
- **Ensure the Entry Supervisor or Attendant contacts the rescue service before any entry into a PRCS to confirm their availability during the entry, and ensure that the rescue service will notify the UW if they are not available during the entry so that the entry can be cancelled.**

## Emergency Services

Emergency Services supplement rescue efforts by providing emergency care to employees injured on site and/or rescued from a PRCS. This could include local 9-1-1 medical emergency services or other specialized services. **The Entry Supervisor or Attendant may need to contact the emergency service before any entry into a PRCS to confirm their availability during the entry, and ensure that the emergency service will notify the UW if they are not available during the entry so that the entry can be cancelled.** Confirming emergency service availability may be important in remote locations.

## Rescue Considerations and Types

Planning is critical to ensure that rescue services and emergency services are capable, available, and prepared to remove Entrants from the space and provide medical or other emergency services. Local fire and emergency resources may not be available in all locations where UW facilities exist; and not all local fire and emergency resources are able to provide effective responses to confined space emergencies.

In developing a **Rescue Plan**, consider the following to help assess the situation, the hazards, potential hazards, and the configuration of the PRCS:

- What rescue equipment would be required to retrieve an Entrant?
- Is the atmosphere safe?

- How severe are the hazards?
- Is the rescue time-sensitive\*?
- Is there an IDLH atmosphere?
- Could a physical hazard result in a fatality if not rapidly responded to?
- Would the space require vertical entry rescue, climbing up or climbing down?
- Would the space require horizontal rescue?
- Are there obstacles in the space that inhibit safe rescue?
- Is there space outside the entrance to set up rescue equipment and conduct an emergency response?
- Does the space entrance have restricted access? (less than 24 inches in any direction, which inhibits use of a self-contained breathing apparatus, SCBA, or rescue stretcher)
- Is the space entrance 4 feet above grade? (may require high angle rescue procedures)

\*An example of a time-sensitive rescue is if an Entrant could be exposed to an IDLH atmosphere and suffer irreversible impairment within four to six minutes. This may require a rescue service to be present at the PRCS, and ready to respond, if needed. An example of a non-time-sensitive rescue, is if an Entrant could be exposed to mechanical hazards that would cause injuries (e.g., broken bones, abrasions) and a response time of 10 or 15 minutes might be adequate.

There are three basic types of confined space rescue:

- **Self-rescue;** when an Entrant is able to leave the PRCS without assistance
- **Non-entry rescue;** when an Entrant is retrieved from the PRCS without anyone entering the space
- **Entry rescue;** when a rescue service enters the PRCS to rescue one or more Entrants

## Complete Rescue Plan on PRCS Entry Form

If feasible, self-rescue is the preferred method for leaving the PRCS in an emergency or when an Attendant orders an evacuation. This should be assumed for any rescue plan unless specifically stated otherwise.

The Rescue Plan section in Part B of the PRCS Entry Form must be completed and approved by the Entry Supervisor before any entry.

Three options are listed in the Rescue Plan table in Part B of the PRCS Entry Form (see below). The options describe common situations and rescue requirements for PRCS entries. Select an option that best describes the planned entry, and add the contact information for the rescue service and the emergency service. Add additional information to the PRCS Entry Form as needed. The rescue plan options with hazard scenario examples and the minimum rescue requirements for each option are described here:

**Option 1 - Low Risk:** This is a relatively low hazard entry, where immediate assistance would not be required (non-time sensitive) in an emergency. The PRCS has unrestricted access (entry access is 24 inches or more in one direction), does not require a high angle rescue, and the interior space is relatively open with no obstacles to impede exiting the space.

Hazard Scenario:

- Non-time sensitive hazard
- Non-entry rescue required

Space examples:

- Empty water tank, ventilated
- Exterior, below grade vault with seepage from surrounding soil
- Pits
- Empty tank with landing platform around entry access for equipment

Hazard examples:

- Hazardous material contamination
- Temperature
- Potential accumulation of water
- Welding fumes
- Chemical exposure below PEL
- Other introduced, non-time sensitive hazard

Rescue Requirements:

- Self-rescue, if feasible
- Non-entry rescue
- Entry rescue service with extraction capability
  - Rescue service evaluation and agreement in place
- Confirmation of available rescue service
- Confirmation (if needed) of available emergency service

**Option 2 - Low to Medium Risk:** This is a low to medium hazard situation, where immediate assistance would not be required (non-time sensitive) in an emergency, but non-entry rescue is not feasible. The space may have restricted access (less than 24 inches across in at least one direction), access may be more than 4 feet above grade, and obstacles may be in space.

Hazard Scenario:

- Non-time sensitive hazard
- Non-entry rescue not feasible due to space configuration and/or obstacles prohibiting rescue

Space example:

- Horizontal entry
- Entry via hatch or ladder with turns or obstacles present

Hazard example:

- Hazardous material contamination
- Temperature
- Potential accumulation of water
- Welding fumes
- Chemical exposure below PEL
- Other introduced, non-time sensitive hazard

Rescue Requirements:

- Self-rescue, if feasible
- Entry rescue service with extraction capability
  - Rescue service evaluation and agreement in place
- Confirmation of available rescue service
- Confirmation (if needed) of available emergency service

**Option 3 -High Risk:** A highly hazardous situation, where immediate assistance would be needed if an Entrant could be exposed to a hazardous atmosphere, be severely injured, or become incapacitated. The space may have inherent hazards that could not be eliminated for the entry.

Space example:

- Sanitary sewer or waste system
- Working on unguarded elevated work platforms inside space

Hazard example:

- Possibility of fall from great height (e.g. an entrant could be suspended and need rapid assistance)
- Potential IDLH atmosphere (e.g. an entrant could suffer irreversible impairment within four to six minutes)
- Severe engulfment hazard (solid or liquid)

Rescue Requirements

- Rescue service with extraction capability, on-site at PRCS standing by to perform entry rescue during Entry
  - Rescue service evaluation and agreement in place
- Non-entry rescue may be performed, if feasible
- Confirmation (if needed) of available emergency service

Below is the Rescue Plan table from Part B of the PRCS Entry Form.

<b>Rescue Plan: Select option that applies or describe plan AND complete contact information.</b>			
Option #	Hazard Scenario (all must apply)	Rescue Requirements	Contact Information
<input type="checkbox"/> Option 1 (baseline)	<ul style="list-style-type: none"> <li>Non-time sensitive hazard</li> <li>Unrestricted access, no obstacles in space, and no hazardous atmosphere</li> </ul>	<ul style="list-style-type: none"> <li>Non-entry rescue</li> <li>Entry rescue service with extraction capability</li> <li>Rescue Evaluation &amp; Agreement in place</li> <li>Confirm available rescue service and, if needed, emergency service</li> </ul>	<input type="checkbox"/> Rescue service contacted Rescue service: Phone number: <hr style="border-top: 1px dotted black;"/> <input type="checkbox"/> Emergency service Emergency service: Phone number:
<input type="checkbox"/> Option 2	<ul style="list-style-type: none"> <li>Non-time sensitive hazard</li> <li>Non-entry rescue not feasible</li> </ul>	<ul style="list-style-type: none"> <li>Entry rescue service with extraction capability</li> <li>Rescue Evaluation &amp; Agreement in place</li> <li>Confirm available rescue service and, if needed, emergency service</li> </ul>	<input type="checkbox"/> Rescue service contacted Rescue service: Phone number: <hr style="border-top: 1px dotted black;"/> <input type="checkbox"/> Emergency service Emergency service: Phone number:
<input type="checkbox"/> Option 3	<ul style="list-style-type: none"> <li>Severe hazards</li> <li>Time sensitive rescue response needed (e.g. IDLH atmosphere, fall from great height, etc.)</li> </ul>	<ul style="list-style-type: none"> <li>On-site entry rescue service at PRCS</li> <li>Non-entry rescue, if feasible</li> <li>Rescue Evaluation &amp; Agreement in place</li> <li>If needed, confirm available emergency service</li> </ul>	<input type="checkbox"/> Rescue service on-site at PRCS Rescue service: Phone number: <hr style="border-top: 1px dotted black;"/> <input type="checkbox"/> Emergency service Emergency service: Phone number:

## Self-Rescue

Self-rescue is when an Entrant is capable of recognizing a hazard and is able to exit from the space with no assistance. Many times self-rescue involves the evacuation of a space when an Entrant feels ill or an alarm sounds on an air monitor. An Entrant must leave the space immediately whenever an Entrant, fellow Entrant, or Attendant recognizes the presence of a hazardous atmosphere, any signs or symptoms of over-exposure, or any other serious space hazards. Self-rescue must also be implemented in the event of forced ventilation system failure during entry when following Alternative Methods. The Entrant(s) must be conscious and fully mobile to self-rescue. Entrants must safely stop whatever they are doing and exit the space in the most expedient and safe manner possible.

Self-rescue may also occur if an Attendant orders an evacuation of the space due to a change of conditions inside and/or outside of the space, Entrants' abnormal behavior, or if the Attendant cannot carry out their duties.

## Non-Entry Rescue

UW departments must plan their entry with the capability of providing rescue through non-entry methods when feasible and without increasing risk of injury to Entrants. This must be documented in the Rescue Plan in Part B of the PRCS Entry Form. A mechanical device to retrieve Entrants from vertical spaces is required for spaces more than five feet deep. Employees must never enter the space during a non-entry rescue. All equipment must be in place before and during entry into the PRCS.

Non-entry rescue is usually only effective in simple vertical or clear horizontal spaces. This method of retrieval must be carefully evaluated before implementation as mechanical retrieval of unconscious or incapacitated Entrants from complex, convoluted spaces can cause serious injuries from entanglement, strangulation, and blunt force impacts. Injured or ill Entrants should be conscious for non-entry rescue. Fellow Entrants may assist in non-entry rescue if safe to do so.



Honeywell-Miller davit arm system  
[www.safety.honeywell.com](http://www.safety.honeywell.com)

### Entry Supervisor and/or Attendant responsibilities during non-entry rescue

- Ensure the mechanical retrieval system is set up properly and ready to use when needed.
- Ensure the Entrant, their harness and retrieval line are clear of any obstacles in the space before starting retrieval.
- Maintain constant communication with Entrant(s) during rescue.
- Attendant executes non-entry rescue.
- Get help in performing the rescue as needed.
- Stop retrieval if it may cause further injury to the Entrant.
- Make calls for rescue services and/or emergency services as needed.



Honeywell-Miller tripod system  
[www.safety.honeywell.com](http://www.safety.honeywell.com)

All units and departments that use or plan to use non-entry rescue as a part of their rescue plan for their permit-required confined spaces must ensure their employees who are PRCS Attendants and Entrants (Entry Supervisors recommended) do the following:

- Be proficient in the set up and use of rescue equipment owned by the department.
- Participate in non-entry rescue practice sessions periodically with department-owned equipment in the actual or a representative permit space owned by the department or unit.
- Be able to safely perform assigned non-entry rescue and emergency duties.
- Be proficient at non-entry rescue procedures in the PRCS.

### **Non-entry rescue feasibility considerations**

If a non-entry rescue fails, the available rescue service designated in the rescue plan must be contacted to respond and conduct an entry rescue. Thus, the feasibility on non-entry rescue should be carefully considered prior to entry if a non-entry rescue would increase the overall risk of injury to Entrants or not contribute to the rescue of the Entrant. Factors to consider in determining if non-entry rescue is feasible include:

#### Space Access

- Vertical – top entry requires rescuers climbing down; bottom entry requires climbing up
- Horizontal – entrance on side of space; use of retrieval lines may be difficult

#### Entrance Size

- Unrestricted – entrance with smallest dimension greater than 24 inches (30 inches recommended) allow free movement in and out
- Restricted – entrance with smallest dimension 24 inches or less too may be difficult to safely retrieve injured entrant

#### Internal configuration

- Open – no obstacles, barriers, or obstructions within space (i.e., water tank)
- Obstructed – space has one or more obstacle (i.e., equipment, ladder, scaffold)

### **Non-entry rescue equipment considerations**

Non-entry confined space rescue equipment consists of three main components:

1. Anchor
  - An anchor holds rescue equipment to a fixed anchorage point outside the space, such as a tripod, davit system, or side-entry system.
2. Connector
  - Often a retrieval line with a winching mechanism (either manual or motorized) connects the outside anchor with the Entrant.

### 3. Body support

- Each Entrant wears a body support, such as a full-body harness.
- The retrieval line is attached to the harness at either the center of the Entrant's back, near shoulder level, above the Entrant's head, or at another point that results in a profile small enough to successfully remove the Entrant from the space.
- If a chest or full-body harness is not feasible or creates a greater hazard, then the Entrant may use wristlets or another device that is the safest and most effective alternative.



Side entry system  
[www.3m.com](http://www.3m.com)

It is critical that the rescue/retrieval equipment be selected based on the characteristics of the confined space and the work to be done.

Read equipment manuals and understand system warnings and limitations, and the capacities for handling persons, materials, and tools. Ask the following questions:

- What system will work best with the space: tripod, davit arm or pole system?
- Is the system capacity designed for retrieving one person, or one person at a time?
- Is the system capable of lowering and raising Entrants and materials into the space?
- How many anchor points are on the system and what are limitations of different anchor points on the system (i.e., side verses center)?
- Is a power driven winch preferred over a manual winch due to depth of entry?

In addition to the above, there are a number of factors to consider if non-entry rescue equipment is also serving as fall protection equipment:

- Anchor points must be rated to 5,000 lb. for fall arrest
- Retrieval self-retracting lifeline (SRL) offers fall arrest
- Are there enough anchor points for all entrants and attendants?
- Can attendant(s) and any others outside the space attach to an anchorage point if they are exposed to fall hazards outside of space (fall restraint)? What limitations, if any, exist?
- Guarding entrance to space with guardrails
- Primary and secondary or backup retrieval device (winch and SRL)



Refer to [Appendix I: Equipment for Confined Space Entry and Rescue](#) for more information on non-entry rescue equipment and examples of setups for specific types of confined spaces.

## Entry Rescue

Unqualified University employees must never perform entry rescue.

Adequate rescue services must be identified and contacted to confirm their availability before entry into a PRCS and documented in Part B, Rescue Plan, of the PRCS Entry Form. Selection and evaluation of rescue services, and having an agreement in place before entry, is discussed above in the Rescue Services section of this document. Emergency services may also need to be contacted before entry to confirm their availability.

The Attendant or Entry Supervisor contacts the rescue service immediately when it is clear that entry rescue is needed to retrieve the Entrant(s). The Attendant or Entry Supervisor also contacts the emergency service to respond to medical or other emergencies.



Entry rescue  
[www.3m.com](http://www.3m.com)

### Entry Supervisor and/or Attendant responsibilities during entry rescue:

- Provide the rescue service with information on the work being done.
- Provide the PRCS Entry Form to rescue service personnel.
- Provide rescue service with any observations or information about the emergency.
- Keep untrained personnel out of the area.
- Provide information on any chemicals with safety data sheets (SDSs) involved in exposures to the emergency responders or the emergency medical department treating exposed Entrants.
- The Entry Supervisor will immediately cancel the PRCS Entry Form.



Rescue service entry rescue  
[www.safery.honeywell.com](http://www.safery.honeywell.com)



Cosham (UK) fire station entry rescue practice with dummy and rescue stretcher

## Accident/Incident Reporting

For all incidents and near misses, the involved person or supervisor completes and submits the UW [Online Accident Reporting System \(OARS\)](#) form within 24 hours (8 hours if serious injury\* or hospitalization). If there is a death, or several people are seriously hurt,\* contact EH&S immediately after providing first aid and/or getting help.

- Call 9-1-1.
- Notify EH&S immediately: During business hours (M-F/8-5) call 206.543.7262.
- After hours on the Seattle campus, call 206.685.UWPD (8973) to be routed to EH&S staff. Outside of the Seattle campus, follow local procedures.

\*A serious injury is defined (by OSHA) as an injury that requires inpatient hospitalization for a period in excess of 24 hours for other than medical observation, or in which an employee suffers a loss of any member of the body, or suffers any serious degree of permanent disfigurement.

[Back to Top](#)

## CONTRACTORS

---

Contractors working at the UW must:

- Provide to their UW point of contact a copy of their company's Confined Space Program documents for review prior to performing work.
- Discuss confined space procedures with all parties involved in the work to ensure that safe work practices and procedures are followed.
- Provide appropriate confined space equipment and systems for employees as required by law, including, but not limited to, ventilation and air monitoring equipment, personal protective equipment and personal rescue retrieval systems as needed or required.
- Complete Job Hazard Analyses and Permit-Required Confined Space Entry Forms (permits) in accordance with regulatory requirements, standards and industry best practices.
- Provide proof of confined space entry training and qualifications.

The UW project manager, hiring manager, or Confined Space Owner who arranges to have another employer (contractor) perform work that involves entry into a UW permit-required confined space must do the following:

1. Inform the contractor:
  - a. The workplace contains permit-required confined spaces and entry is allowed only if the applicable requirements in WAC 296-809 are met.
  - b. Of the identified hazards and your experience with each permit-required confined space

- c. Of any precautions or procedures you require for the protection of employees in or near spaces where the contractor will be working
2. Coordinate entry operations with the contractor, when either employees or employers from different companies will be working in or near permit-required confined spaces.
3. Discuss entry operations with the contractor when they are complete. Include the following in your discussion:
  - a. The program followed during confined space entry
  - b. Any hazards confronted or created

Note: All employers are responsible for following confined space requirements in WAC 296-809 and in other WAC regulations that apply.

[Back to Top](#)

## AUDITS, INSPECTIONS, CERTIFICATIONS

---

- EH&S and individual units or departments must conduct audits periodically of the Confined Space Program. The audit may review all PRCS entries performed during a 12-month period and assess the departmental procedures against the requirements in this document and correct any deficiencies before allowing subsequent entries in a space(s).
- Review the UW program and written documents periodically to ensure personnel are being adequately protected and the program is updated if there are any regulation changes or any other circumstances that require updating.
- Conduct inspections and certifications as required for the following:
  - Inspect PRCSs to ensure signage is posted and area is secured to prevent unauthorized entry.
  - Inspect and maintain harnesses, retrieval lines, tripod/wench, PPE, ladders, rescue and emergency equipment.
  - Maintain and calibrate testing and monitoring equipment as required.
  - Inspect and maintain equipment including: ventilation, communication, portable lighting, alarm systems, barriers.

[Back to Top](#)

## RECORDKEEPING

The following records will be retained according to the UW and regulatory record retention requirements.

University department/unit/organization will retain the following records:

Record Type	Minimum Retention Time
PRCS Entry Forms	1 year after date of cancellation
PRCS Entry Forms with air monitoring data or summaries of the data	30 years after date of entry
Confined space evaluations	Duration of existence of the confined space
Confined space inventory	Duration of existence of the confined space
PRCS Emergency and Rescue Services Evaluation forms	1 year
Employee training	7 years
Employee respirator training	Duration of employment
Employee respirator fit test results	Until retested
Completed Fall Protection Work Plans	6 years or as long as the fall hazard exists at the building or area, whichever is longer
Annual inspection checklists of fall protection equipment (e.g., harnesses, lanyards, connectors)	6 years
Annual inspection checklists of portable and fixed ladders	6 years

EH&S will retain the following records:

Record Type	Minimum Retention Time
Exposure assessments/Air monitoring data	30 years after date of air monitoring/assessment
Employee training	7 years
Respiratory protection training	Duration of employment
Respirator fit test results	Until retested
Medical records	Duration of employment plus 30 years

[Back to Top](#)

## REFERENCES

---

[WAC 296-809 – Confined Spaces](#) – Washington’s Department of Occupational Safety and Health (DOSH) publishes rules pertaining to confined space safety.

[OSHA Confined Spaces](#) – Federal Occupational Safety and Health Administration, standards, guidance and resources.

[The American Industrial Hygiene Association](#) – Prevention through Design: Eliminating Confined Spaces and Minimizing Hazards

[OSHA Quick Card: Permit-Required Confined Spaces](#) – Assists with quickly remembering the most important confined space safety issues

[NFPA 350: Guide for Safe Confined Space Entry and Work](#) – National Fire Protection Association. (2016)

[ANSI/ASSE Z117.1 Committee. Safety Requirements for Entering Confined Spaces](#) – American Society of Safety Engineers /American National Standards Institute. (2016)

[Back to Top](#)

## APPENDICES

---

### Appendix A: Definitions

#### **Acceptable Entry Conditions**

The conditions that must exist in a permit-required confined space to allow employees to safely enter and work within the space.

#### **Alternative Methods**

An alternative process for entering a permit space under very specific conditions. These methods include documentation showing the elimination of any physical and (actual or potential) atmospheric hazards.

#### **Atmospheric Hazards**

An atmosphere that may expose employees to the risk of death, incapacitation, impairment of ability to self-rescue (escape unaided from a permit-required confined space), injury, or acute illness from one or more of the following:

- Flammable gas, vapor, or mist in excess of 10 percent of its lower flammable limit (LFL) or lower explosive limit (LEL);
- Airborne combustible dust at a concentration that meets or exceeds its LFL. The concentration may be approximated as a condition in which the dust obscures vision at a distance of five feet (1.52 meter) or less.
- Atmospheric oxygen concentration below 19.5 percent or above 23.5 percent;
- Atmospheric concentration of any substance for which may exceed a permissible exposure limit (PEL).
- Any other atmospheric condition that is immediately dangerous to life and health.

#### **Atmospheric Testing**

See definition of monitoring or testing.

#### **Attendant**

An individual stationed outside the permit space who monitors the Entrant(s) and who performs all attendants' duties assigned in the permit space program.

#### **Barrier**

A physical object that blocks or limits access.

### **Blanking or blinding**

The absolute closure of a pipe, line, or duct by fastening a solid plate (such as a spectacle blind or a skillet blind) that completely covers the bore. It is capable of withstanding the maximum pressure of the pipe, line, or duct with no leakage beyond the plate.

### **Bump Test**

A qualitative functional test of a gas monitor to confirm that the sensors and alarms will respond to their target gas per the monitor manufacturer's instruction manual. The sensor(s) are exposed to their target gas(es) at a concentration and exposure time that will activate alarms. The test should be performed before each day's use.

### **Calibration**

Checking a direct reading instrument against an accurate standard such as a calibration gas to determine deviation and correction for analytical errors.

### **Competent Person**

A person capable of identifying existing and predictable hazards in the surrounding or working conditions including those that are unsanitary, hazardous, or dangerous to employees, and have the authorization to evaluate a confined space.

### **Confined Space**

A space that meets all the following criteria:

- Is large enough and so configured that an employee can bodily enter and perform assigned work
- Has limited or restricted means for entry or exit. Examples of spaces with limited or restricted entry are tanks, vessels, silos, storage bins, hoppers, vaults, excavations, and pits
- Is not designed for continuous employee occupancy.

### **Confined Space Owner**

The department or individual (building coordinator, department safety coordinator, principal investigator and/or researcher) who owns, controls access, and/or has administrative control over a confined space and understands the chemical and physical hazards associated with it.

### **Control**

The action taken to reduce the level of any hazard inside a confined space using engineering methods (for example, ventilation), and then using these methods effectively to maintain the reduced hazard level. Control also refers to the engineering methods used for this purpose. Personal protective equipment is not a control.

### **Double block and bleed**

The closure of a line, duct, or pipe by closing and locking or tagging two in-line valves and by opening and locking or tagging a drain or vent valve in the line between the closed valves.

### **Emergency**

Any occurrence (including any failure of hazard control or monitoring equipment) or event, internal or external, to the permit space that could endanger entrants.

### **Energy-Isolating Device**

A mechanical device that physically prevents transmitting or releasing energy. This includes, but is not limited to:

- Manually operated electrical circuit breakers
- Disconnect switches
- Manually operated switches that disconnect the conductors of a circuit from all underground supply conductors if no pole of the switch can be operated independently
- Line valves
- Blocks
- Similar Devices

Note: Push-button, selector switches and other control circuit-type devices are not energy isolating devices.

### **Engulfment**

The surrounding capture of a person by a liquid or finely divided (flow-able) solid substance that can be inhaled to cause death by filling or plugging the respiratory system or that can exert enough force on the body to cause death by strangulation, constriction, or crushing.

### **Entrant**

Employee who is trained to enter a permit space.

### **Entry**

Action by which a person passes through an opening into a permit-required confined space and includes work activities in that space. Entry occurs as soon as any part of the entrant's body breaks the plane of the opening into the space whether or not such action is intentional or any work activities are actually performed in the space.

### **Entry Rescue**

Occurs when a rescue service enters a permit space to rescue one or more Entrants.



### **Entry Supervisor**

The qualified and trained person (such as the employer, crew leader, or crew chief) responsible for identifying permit-required confined spaces and performing responsibilities and job duties as outlined by WAC 296-809-50018. For example:

- Determining if acceptable entry conditions are present at a permit-required confined space where entry is planned
- Authorizing entry and overseeing entry operations
- Terminating entry as required by this safety manual.

### **Hazard**

A physical hazard or an atmospheric hazard.

### **Hazardous atmosphere**

See Atmospheric Hazards.

### **Hazard elimination**

The temporary or permanent action taken to remove a hazard from the work environment. For confined spaces, this definition includes isolation. It does not include the use of forced air ventilation. For a hazard to be considered eliminated, the conditions that create or cause the hazard must no longer exist within the confined space.

### **Hot Work**

Operations capable of providing a source of ignition: riveting, welding, cutting, burning, and heating.

### **Hot Work Permit**

A written authorization to perform [Hot Work operations](#).

### **Immediately Dangerous to Life or Health (IDLH)**

Any condition that poses an immediately or delayed threat to life or what would cause irreversible adverse health effects or that would interfere with an individual's ability to escape unaided from a permit space.

## **Isolation**

Isolation. The process of removing a permit-required confined space from service and completely protecting the employees against the release of energy and material into the space by:

- Blanking or blinding;
- Misaligning or removing sections of lines, pipes, or ducts;
- Double block and bleed system;
- Machine guarding;
- Blocking or disconnecting all mechanical linkages;
- Placement of barriers to eliminate the potential for employee contact with a physical hazard; or
- Lockout of all sources of energy.

## **Limited or Restricted Entry or Exit**

A condition that has a potential to impede an employee's movement into or out of a confined space. A space has limited or restricted means of entry or exit, if an entrant's ability to escape in an emergency would be hindered. Examples include but are not limited to, trip hazards, poor lighting, slippery floors, inclining surfaces and ladders.

Other examples include:

- To enter or exit the space an employee must crawl, climb, twist, be constrained in a narrow opening, follow a lengthy path or otherwise exert unusual effort.
- The entrance may become sealed or secured against opening from the inside.
- An access door or portal that is too small to allow an entrant to walk upright and unhindered through it is considered a limited entry or exit.
- A door configuration that requires a person to step over a raised threshold is considered a limited entry or exit.

## **Line breaking**

The intentional opening of a pipe, line, or duct that is or has been carrying flammable, corrosive, or toxic material, an inert gas, or any fluid at a volume, pressure, or temperature capable of causing injury. Safe work plan and approval needed before line breaking.

## **Lower Explosive Limit (LEL)**

The minimum concentration of a substance in air needed for an ignition source to cause a flame or explosion.

## **Monitor or monitoring (see also testing)**

The process used to identify and evaluate a potential hazardous atmosphere after an entrant enters the space. This process checks for atmospheric changes. It is performed in a periodic or continuous manner after the completion of the initial testing or evaluation of that space.

## **Non-Entry Rescue**

Retrieval of an entrant from a permit-required space without entering the permit space.

## **Permit-Required Confined Space (Permit Space)**

A confined space that has one or more of the following characteristics:

- Contains or has the potential to contain a hazardous atmosphere
- Contains a material that has the potential for engulfing an entrant
- Has an internal configuration such that an entrant could be trapped or asphyxiated by inwardly converging walls or by a floor, which slopes downward and tapers to a smaller cross-section
- Contains any other recognized serious safety or health hazard that could either:
  - Impair the ability to self-rescue; or
  - Result in a situation that presents an immediate danger to life or health (IDLH).

## **Permit Required Confined Space (PRCS) Entry Form**

The UW written or printed document that is completed and approved to allow and control safe entry into a permit-required confined space and that contains the information required in WAC 296-809-500, Permit entry procedures.

## **Physical Hazard**

An existing or potential hazard that can cause death or physical damage. Examples include but are not limited to:

- Explosives
- Mechanical
- Hydraulic
- Chemical
- Engulfment
- Noise
- Temperature extremes
- Gravity
- Radiation
- Electrical
- Pneumatic
- Biological

## **Potential Hazard**

All reasonable anticipated conditions within a space and outside the space that can adversely affect the conditions within a space.

- Flooding
- Atmospheric changes
- Fall Hazard

### **Qualified person**

A person who has successfully demonstrated the ability to solve problems relating to the subject matter, work, or project, either by:

- Possession of recognized degree, certificate, or professional standing
- Extensive knowledge, training and experience

### **Representative permit space**

Used for annual rescue drills or practice. A mock-up of a confined space that has entrance openings that are similar to, and is of similar size, configuration, and accessibility to, the permit space that trained entrants enter.

### **Rescue**

Retrieving and providing medical assistance to one or more entrants in a permit space.

### **Rescue service**

The personnel designated to rescue entrants from permit-required confined spaces.

### **Retrieval system**

The equipment used for non-entry rescue of entrants from permit-required confined spaces including; a retrieval line, chest or full-body harness, wristlets or anklets if appropriate, and a lifting device or anchor

### **Testing (see also monitoring)**

The process of identifying and evaluating the hazards that entrants may be exposed to in a permit-required confined space. Testing includes specifying the initial atmospheric tests that are to be performed in the permit-required confined space.

### **Ventilate or Ventilation**

The process of controlling a hazardous atmosphere using continuous forced-air mechanical systems. Ventilation is a method of hazard control, not hazard elimination.

[Back to Top](#)

## Appendix B: Examples of Confined Spaces

Source: WAC 296-809, Confined Spaces, Non-Mandatory Appendix A

Confined spaces occur in many industries, such as agriculture; aerospace; beverage-making, including fermented beverages (such as breweries and wineries); chemicals; construction; food processing and storage; chemical processing and storage; electrical power generation; manufacturing; municipal and public utility systems; gas stations; metals; pulp and paper manufacturing; water and wastewater treatment; transportation; and wood products.

Confined spaces have many shapes, sizes, and uses. For example, tanks for storing or processing liquids, pressure vessels, sewer systems, septic tanks, underground utility vaults and chambers, open topped tanks, vats, secondary chemical containment, trenches, storage bins, silos and hoppers. **Other specific examples include, but are not limited to:**

- Adhesive mixers
- Adhesive tanks
- Aggregate bins
- Air pollution equipment including air scrubbers
- Anaerobic digesters
- Attics
- Autoclaves
- Bag houses+
- Balers
- Bins like grain bins
- Blast furnaces
- Blast recovery pits
- Bleach tanks
- Boilers
- Bridge box girders and enclosed beams
- Caustic soda tanks
- Caissons
- Cesspools and pits
- Chimneys and stacks
- Cooling towers
- Chillers
- Clay hopper
- Composters
- Compactors
- Controlled atmosphere (CA) rooms (sealed)
- Concrete mixers
- Construction related:
  - Caissons
  - Crawl spaces and attics
  - Excavation and trenches -
    - Associated confined spaces including manholes, piping, pits, sewers,
    - See also Chapter 296-155 WAC
  - Pits

- Manhole units
  - Precast concrete units
  - Sewers – see water treatment systems
  - Vaults
  - Tanks
- Conveyor enclosures
- Crawl spaces
- Crude oil tank cars/trucks
- Crushers
- Cyclones
- Degreaser
- Digesters
- Dip tanks
- Dropped ceilings
- Dikes and diked areas
- Duct work
- Dust collectors (including wood dust)
- Drums
- Drying ovens
- Fermenters
- Food and beverage processing and storage including: breweries, wineries, milk processing, eggs (including rotten eggs), fruit, corn syrup, water, chocolate, oil and grease, and vegetables.
  - Batch cookers
  - Bins
  - Containers
  - Controlled atmosphere rooms (CA rooms)
  - Continuous cookers
  - Conveyor enclosures
  - Drying ovens
  - Grease pits and tanks
  - Kettles
  - Mixers
  - Ovens
  - Heated lard tanks
  - Heated liquid sugar bins
  - Hoppers
  - Hydrogenators
  - Pits
  - Silos for flour and grains
  - Tanks
  - See also Waste water
  - Vessels
- Furnaces
- Heating and cooling ventilation ductwork
- Hoppers
- Hydrapulpers

- Hydrogen reformer furnace
- Ice “houses”
- Incinerators
- Irrigation dam outlet towers
- Irrigation siphons
- Kilns
- Manholes sewers, storm drains, communication and other utility
  - Precast concrete and other preformed manhole structures
- Mixers and mix tanks
- Mills
- Mobile
  - Bark blowers
  - Concrete mixers
  - Garbage trucks
  - Rail tanks
  - Tanker trucks including: gas, oil, milk
  - Vacuum truck tanks
- Ovens
- Pressure vessels (including boilers)
- Precipitators
- Process and storage containers, kettles, pits, tanks and vessels:
  - See also Food processing
  - Chemical storage tanks and processing vessels like: Bio diesel, degreasing tanks, gasoline, acids, bases, solvents, scrubbers (Air pollution), water treatment
  - Electroplating and pickling tanks
  - Furnaces
  - Water and waste water
- Pits including:
  - Elevator pits
  - Grease
  - Manure pits
  - Slag
  - Steam
  - Swimming pool surge pits
  - Utility
  - Valve
- Pipes and pipelines
- Rail tank cars
- Reaction and reactor vessels
- Recycle and transfers station
  - Balers
  - Compactors
- Reservoirs
- Water and water treatment systems including:
  - Bar screen enclosures
  - Drains
  - Digesters

- Grease traps
- Irrigation siphons
- Lift and pumping stations
- Manholes
- Manure pits
- Pits
- Sanitary, storm sewer and waste water systems
- Septic tanks
- Tanks
- Utility vaults
- Water tanks and reservoirs
- Wet wells
- Valve pits
- Silos and hoppers including:
  - Animal feed
  - Ash collection
  - Chip
  - Chemicals
  - Cement
  - Grain
  - Sawdust
  - Slag
  - Silage (corn, hay, beet)
  - Soaking
- Shafts
- Shredders
- Scrubbers
- Sludge pits
- Sulfuric acid tanks
- Tanks and Vats (including portable)
  - Adhesive
  - Bleach
  - Chemical
  - Food processing
  - Fuel
  - Mobile
  - Sewer and septic tanks
  - Solvent and solvent recovery
  - Water and waste water
- Tanker vessels
- Tunnels
- Vaults including utility: dust, electrical, transformers, water, sewer, steam, valves
- Water towers
- Wind machines:
  - Blades
  - Nacelle



Note: This list is not all inclusive of all confined spaces in the industry. It is intended to provide the user with variety of examples for illustration.

For additional information, see the OSHA website OSHA.gov for the Compliance Directive [https://www.osha.gov/sites/default/files/enforcement/directives/CPL\\_02-00-100.pdf](https://www.osha.gov/sites/default/files/enforcement/directives/CPL_02-00-100.pdf) and OSHA Confined Spaces Advisor <http://webapps.dol.gov/elaws/confined.htm>.

[Back to Top](#)

## Appendix C: Confined Space Evaluation Form

A fillable Confined Space Evaluation Form can be accessed [here](#).

See next page.

[Back to Top](#)



## Appendix D: EH&S Approved PRCS Signage

If a UW department/unit/organization is responsible for a space that has been evaluated and documented by a Competent Person to be a permit-required confined space, the Confined Space Owner designated by the UW department/unit/organization is responsible for labeling the space.

By law, all permit-required confined spaces must be labeled with a sign reading “Danger-Permit Required Confined Space, DO NOT ENTER,” or using pictures or other similar wording employees can understand would satisfy the requirement for a sign. In addition, measures to prevent employee entry into the space should be taken. Examples include: padlocks, bolted covers, use of special tools to remove covers, along with employee training, and permanently closing the space, such as welding it closed.



### Online sources:

Signs  
[Airgas](#)  
[Grainger](#)  
[My Safety Sign](#)

Stencils  
[Airgas](#)  
[Seton](#)  
[My Safety Sign](#)

## Appendix E: Permit-Required Confined Space Entry Flow Chart

Flow chart based on similar chart in the Confined Space Standard WAC 296-809.

See next page.

[Back to Top](#)

## You determined that you have a confined space

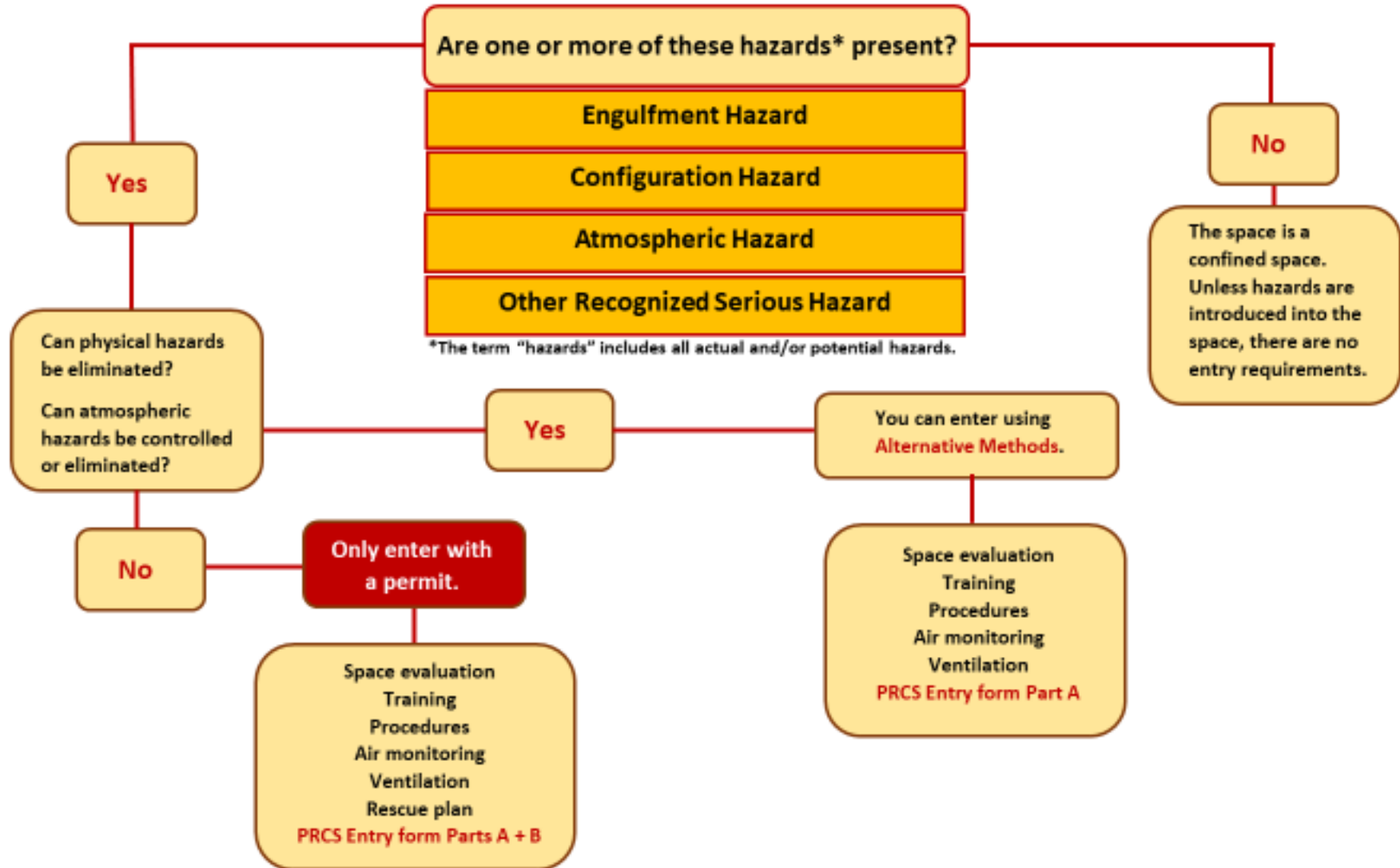

## Appendix F: Permit-Required Confined Space Entry Form

A fillable Permit-Required Confined Space Entry Form can be accessed [here](#).

See next page.

[Back to Top](#)

## Permit Required Confined Space (PRCS) Entry Form

(1) Identify all physical and atmospheric hazards in the PRCS. (2) Determine control of hazards through elimination, control, safe work practices, or use of appropriate PPE until hazards addressed. **This PRCS entry permit is valid for one day only.**

General Information		
Date:	Entry Start Time:	Projected Entry Duration:
Department Responsible for Entry:		Purpose of Entry:
Location and Description of Space:		
Entry Supervisor:	Entry Entrant(s):	Is a contractor entering the space? <input type="checkbox"/> Yes <input type="checkbox"/> No <b>Contractor Name</b> _____ <i>I understand the hazards in this space and have current training on my company's Permit Required Confined Space entry program. <b>Contractor Entrant Signature</b> _____</i>
Phone:		
Communication Procedures (include communication equipment, channels, etc.):		

### Part A: Evaluate the hazards present in the permit required confined space

Hazard or Potential Hazard	Hazard Control	Hazard Eliminated?
<b>Physical Hazards</b>		
<input type="checkbox"/> <b>Fall Hazards</b> <b>Related to activities in space:</b> <input type="checkbox"/> 4ft.-10 ft. <input type="checkbox"/> 10 ft.+ <input type="checkbox"/> Hole/Floor Opening <input type="checkbox"/> Elevated Platforms <input type="checkbox"/> Other _____ <b>Related to access into space:</b> <input type="checkbox"/> Hatch/manway <input type="checkbox"/> Ladder Entry (height ____ft.) <input type="checkbox"/> Fixed <input type="checkbox"/> Portable: Type _____	<b>Activities in space:</b> <input type="checkbox"/> Fall Protection Work Plan (attach to Entry Form) <input type="checkbox"/> Personal Fall Restraint <input type="checkbox"/> Personal Fall Arrest <input type="checkbox"/> Other _____ <b>Access into the space:</b> <input type="checkbox"/> Guardrails outside <input type="checkbox"/> Ladder safety system <input type="checkbox"/> Fall arrest system <input type="checkbox"/> Portable ladder entry <input type="checkbox"/> Other _____	<input type="checkbox"/> Yes <input type="checkbox"/> No (Part B required)
<input type="checkbox"/> <b>Hazardous Energy (List all sources)</b> <input type="checkbox"/> Electrical <input type="checkbox"/> AC ____volts <input type="checkbox"/> DC/stored ____volts <input type="checkbox"/> Chemical <input type="checkbox"/> Pumps <input type="checkbox"/> Hydraulic <input type="checkbox"/> Pumps <input type="checkbox"/> Thermal <input type="checkbox"/> Ambient temperature <input type="checkbox"/> Steam line <input type="checkbox"/> Pressurized piping system <input type="checkbox"/> Mechanical <input type="checkbox"/> Moving parts <input type="checkbox"/> Springs <input type="checkbox"/> Pneumatic <input type="checkbox"/> Compressor <input type="checkbox"/> Cylinder <input type="checkbox"/> Gravity <input type="checkbox"/> Other _____	<input type="checkbox"/> Equipment-Specific Lockout/Tagout Procedure (attach to Entry Form) <input type="checkbox"/> Energized Electrical Work Plan (attach to Entry Form) <input type="checkbox"/> Locks and Tags <input type="checkbox"/> Blocks <input type="checkbox"/> Double Block and Bleed <input type="checkbox"/> Flange <input type="checkbox"/> Disconnect <input type="checkbox"/> Pin <input type="checkbox"/> Engineering control: _____ <input type="checkbox"/> Other _____	<input type="checkbox"/> Yes <input type="checkbox"/> No (Part B required)
<input type="checkbox"/> <b>Inadequate Lighting</b>	<input type="checkbox"/> Portable Lighting <input type="checkbox"/> Personal Lighting <input type="checkbox"/> Explosion-proof <input type="checkbox"/> Other _____	<input type="checkbox"/> Yes



**ENVIRONMENTAL HEALTH & SAFETY**

Confined Space #: \_\_\_\_\_

UNIVERSITY of WASHINGTON

<input type="checkbox"/> <b>Engulfment</b> <input type="checkbox"/> Liquid _____ <input type="checkbox"/> Solid _____	<input type="checkbox"/> Platform <input type="checkbox"/> Removal/drain/siphon _____	<input type="checkbox"/> Other _____	<input type="checkbox"/> Yes <input type="checkbox"/> No (Part B required)
<input type="checkbox"/> <b>Configuration</b> <input type="checkbox"/> Entrapment <input type="checkbox"/> Sloping floor	<input type="checkbox"/> Temporary rope/ladder <input type="checkbox"/> Platform	<input type="checkbox"/> Other _____	<input type="checkbox"/> Yes <input type="checkbox"/> No (Part B required)
<input type="checkbox"/> <b>Hazards in space</b> <input type="checkbox"/> Falling objects <input type="checkbox"/> Biological agents <input type="checkbox"/> Sharp objects	<input type="checkbox"/> Contaminated surface <input type="checkbox"/> Wet environment <input type="checkbox"/> Loose, unstable materials <input type="checkbox"/> Radioactive material	<input type="checkbox"/> Noise <input type="checkbox"/> Other _____ <input type="checkbox"/> Removal <input type="checkbox"/> See PPE/Tools below <input type="checkbox"/> Isolate/cover <input type="checkbox"/> Shield	<input type="checkbox"/> Clean and disinfect or sterilize <input type="checkbox"/> Other _____ <input type="checkbox"/> Yes <input type="checkbox"/> No (Part B required)
<input type="checkbox"/> <b>Vehicle and pedestrian traffic</b>	<input type="checkbox"/> Barricade/fence <input type="checkbox"/> Cones	<input type="checkbox"/> Flagger <input type="checkbox"/> Other _____	<input type="checkbox"/> Yes
<input type="checkbox"/> <b>Sparks and open flame</b>	Continue to Part B		<input type="checkbox"/> No (Part B required)
<input type="checkbox"/> <b>Other:</b>	<input type="checkbox"/> Controls:		<input type="checkbox"/> Yes <input type="checkbox"/> No (Part B required)

Hazard or Potential Hazard	Hazard Control	Hazard Eliminated?
<b>Atmospheric Hazards</b>		
<input type="checkbox"/> Continuous flow system <input type="checkbox"/> Sanitary sewer or waste system <input type="checkbox"/> Oxygen Deficient <input type="checkbox"/> Rust <input type="checkbox"/> Decomposing organic matter <input type="checkbox"/> Fumes/Vapors/Mists/Gases	<input type="checkbox"/> Flammable/Explosive <input type="checkbox"/> Dust/Particulates <input type="checkbox"/> Oxygen Enriched <input type="checkbox"/> Chemical (s): _____ <input type="checkbox"/> Introduced Hazards (grinding, descaling, painting, welding, etc.) _____ <input type="checkbox"/> Underground vault/manhole <input type="checkbox"/> Other: _____	<input type="checkbox"/> Continuous Ventilation <input type="checkbox"/> Fixed <input type="checkbox"/> Portable <input type="checkbox"/> Purge Ventilation <input type="checkbox"/> Isolate source/system <input type="checkbox"/> Local exhaust
<input type="checkbox"/> Yes, can be eliminated <input type="checkbox"/> Yes, can be controlled with continuous ventilation <input type="checkbox"/> No (Part B required)		

If atmospheric hazards or potential atmospheric hazards are present, **Ventilation** and **Atmospheric Testing** sections are **REQUIRED**.

Ventilation					
Specify the type of ventilation used: <input type="checkbox"/> Fixed <input type="checkbox"/> Portable		Volume of space (L x W x H in cubic feet) = Air changes = 20 (per hour) Ventilation Rate (CFM) =		Amount of time (minutes) need to ventilate prior to Entry = Volume of space (Cubic Feet) x 20 Air Changes ÷ Flow Rate (CFM)	
<input type="checkbox"/> N/A					
Atmospheric Testing					
Substance Monitored:	Permissible Levels:	Initial test Time/ Results	Time/Results	Time/Results	Time/Results
Oxygen (O <sub>2</sub> ) levels	19.5% - 23.5%				
Lower Explosive Limit (LEL)	<10%				
Carbon Monoxide (CO)	<35 ppm				
Hydrogen Sulfide (H <sub>2</sub> S)	<10 ppm				
Other:					

List all instrumentation for Atmospheric Testing and/or Monitoring			
Instrument name	Model number:	Last Calibration Date:	Bump test
			<input type="checkbox"/> Pass
			<input type="checkbox"/> Pass
			<input type="checkbox"/> Pass

PPE /Tools Required	Type of PPE/Tools	PPE /Tools Required	Type of PPE/Tools
<input type="checkbox"/> Gloves		<input type="checkbox"/> Tool belt	
<input type="checkbox"/> Personal Fall Protection		<input type="checkbox"/> Voltmeter	
<input type="checkbox"/> Coveralls (Tyvek)		<input type="checkbox"/> Respirator & cartridge	
<input type="checkbox"/> Safety Glasses		<input type="checkbox"/> Hearing Protection	
<input type="checkbox"/> Goggles		<input type="checkbox"/> FPR Clothing (Arc Flash)	
<input type="checkbox"/> Face Shield		<input type="checkbox"/> Non-sparking tools	
<input type="checkbox"/> Bump cap/Hard Hat		<input type="checkbox"/> Other:	
<b>All PPE/Tools inspected before use? <input type="checkbox"/> Yes <input type="checkbox"/> No</b>			

List optional controls (e.g. attendant):

***If all physical hazards are eliminated from the space, and all atmospheric hazards are eliminated or controlled with continuous ventilation, Entrant(s) can enter with Alternative Methods. Are all physical and atmospheric hazards controlled or eliminated?***  YES  NO

**If YES, Entry Supervisor signs below and Entrant(s) move forward with entry procedure. If NO, complete Part B.**

Entry Supervisor Signature:

Post Entry Notes about the space & entry (including whether evacuation was necessary):

**Entrant(s) maintain completed Entry Form and any SDSs for chemicals used or present in the space. If hazardous condition or atmosphere is created, the Entrant(s) must exit the space and notify the Entry Supervisor.**

**Retain completed Entry Form for 1 year after entry.**

This is the end of Part A.

**Part B: Complete information for all hazards not eliminated/controlled in Part A**

Hazards still present (not eliminated in Part A)	Plan to control or mitigate existing hazards during entry

Establish Attendant(s):	Name(s):
-------------------------	----------

**Rescue Plan: Select option that applies or describe plan AND complete contact information.**

Option #	Hazard Scenario (all must apply)	Rescue Requirements	Contact Information
<input type="checkbox"/> Option 1 (baseline)	<ul style="list-style-type: none"> <li>Non-time sensitive hazard</li> <li>Unrestricted access, no obstacles in space, no hazardous atmosphere</li> </ul>	<ul style="list-style-type: none"> <li>Non-entry rescue</li> <li>Entry rescue service with extraction capability</li> <li>Rescue Evaluation &amp; Agreement in place</li> <li>Confirm available rescue service and, if needed, emergency service</li> </ul>	<input type="checkbox"/> Rescue service contacted Rescue service: Phone number: <input type="checkbox"/> Emergency service Emergency service: Phone number:
<input type="checkbox"/> Option 2	<ul style="list-style-type: none"> <li>Non-time sensitive hazard</li> <li>Non-entry rescue not feasible</li> </ul>	<ul style="list-style-type: none"> <li>Entry rescue service with extraction capability</li> <li>Rescue Evaluation &amp; Agreement in place</li> <li>Confirm available rescue service and, if needed, emergency service</li> </ul>	<input type="checkbox"/> Rescue service contacted Rescue service: Phone number: <input type="checkbox"/> Emergency service Emergency service: Phone number:
<input type="checkbox"/> Option 3	<ul style="list-style-type: none"> <li>Severe hazards</li> <li>Time sensitive rescue response needed (e.g. IDLH atmosphere, fall from great height, etc.)</li> </ul>	<ul style="list-style-type: none"> <li>On-site entry rescue service at PRCS</li> <li>Non-entry rescue, if feasible</li> <li>Rescue Evaluation &amp; Agreement in place</li> <li>If needed, confirm available emergency service</li> </ul>	<input type="checkbox"/> Rescue service on-site at PRCS Rescue service: Phone number: <input type="checkbox"/> Emergency service Emergency service: Phone number:

If atmospheric/potential atmospheric hazards are present, atmospheric monitoring (next page) is required before and during entry.

**Entrant(s) maintain completed Entry Form and any SDSs for chemicals used or present in the space. Retain completed Entry Form for 1 year after entry.**

<i>Once all controls are in place, obtain Entry Supervisor's signature before entering the confined space. This Entry Form is the "Permit" to enter the PRCS.</i>	
<b>Approval for Entry</b>	Entry Supervisor's Signature:
<b>Entry Completion &amp; Review</b>	Entry End Time: <b>Post Entry Notes</b> , comments, problems during entry (if evacuation was necessary), and contractor touch base:

Ventilation & Atmospheric Monitoring																	
If LEL is greater than 10% STOP ENTRY & EVACUATE, continue ventilation. If LEL is greater than 50% STOP ENTRY, EVACUTE, STOP VENTILATION, Cancel Entry Form.																	
Test (Pre-ventilation, upon entry, and at least every 15 minutes during entry)	Time	Initials	Oxygen (O <sub>2</sub> ) Range (19.5 - 23.5% range for entry) <small>Normal - 20.8% or 20.9%</small>			Lower Explosive Limit (LEL) (<10% for entry)			Carbon Monoxide (CO) (<35 PPM for entry)			Hydrogen Sulfide (H <sub>2</sub> S) (<10 PPM for entry)			Other:		
			Top	Middle	Bottom	Top	Middle	Bottom	Top	Middle	Bottom	Top	Middle	Bottom	Top	Middle	Bottom
Pre-Ventilation																	
Entry (0 min)																	
Exit																	

## Appendix G: Ventilation Practices in Confined Spaces – Effective Positioning of Ventilation Equipment

When working in a confined or enclosed space, ventilation is the best means of reducing exposure to airborne contaminants. However, poorly installed or improperly used ventilation can provide little to no protection for workers. Therefore, it is imperative to understand basic ventilation practices that include effective positioning of ventilation equipment.

### Prevent short-circuiting and chimney effect

During the installation and use of a ventilation system, it is important to ensure that short-circuiting is not occurring; short-circuiting occurs when only a small portion of the space is ventilated. This occurs most often when a space has only one access opening. Figures 2 and 3 show short-circuiting in the exhaust and supplied modes.

As shown in Figures 2 and 3, the placement of a ventilation system (e.g., air mover) at the space opening only circulates air in a small area around the opening and provides little protection for the worker. To provide adequate ventilation for the worker in the space, the air needs to be directed in close proximity to the worker. Normally this is done by positioning a hose or ducting in the location where the task is being performed. In addition, it is important to ensure that the ventilation system is moved away from the space opening (Figure 4). This permits easier worker access to the space and reduces the chance of reintroducing contaminated air back into the space.

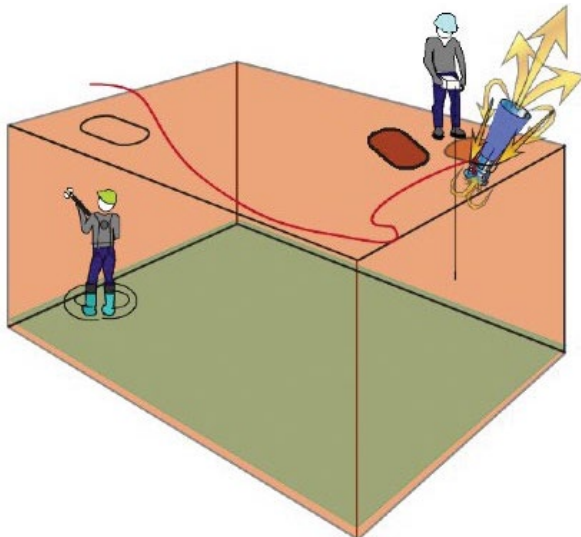

Figure 2: Shows **exhaust ventilation** being short-circuited.

Source: ([www.osha.gov](http://www.osha.gov)) Edward J. Willwerth, Atlantic Environmental & Marine Services

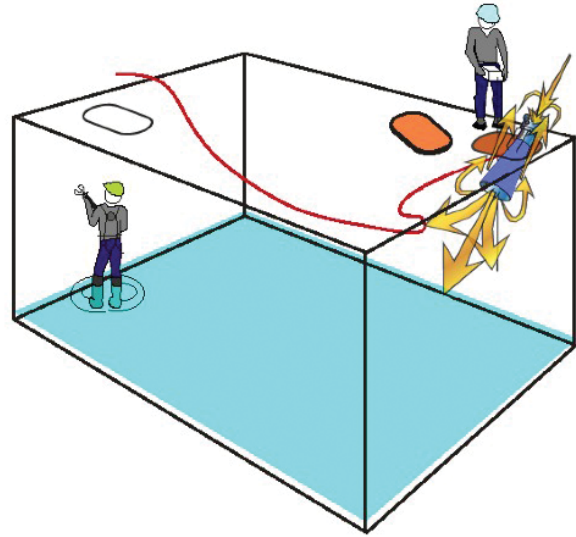

Figure 3: Shows **supplied ventilation** being short-circuited.

Source: ([www.osha.gov](http://www.osha.gov)) Edward J. Willwerth, Atlantic Environmental & Marine Services

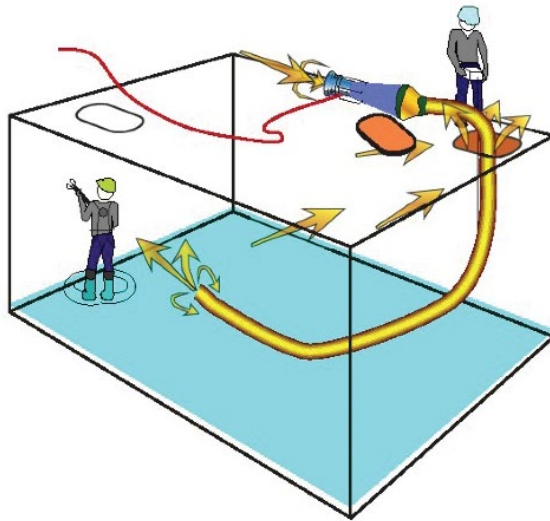

Figure 4: Shows efficient method of supplied ventilation (forced air) with system away from space opening and ventilation ducting placed near the work area.

Source: ([www.osha.gov](http://www.osha.gov)) Edward J. Willwerth, Atlantic Environmental & Marine Services

The chimney effect is illustrated below (Figure 5) when supplied air ventilation ducting is not low enough or positioned properly in the space, resulting in incomplete ventilation. Using a longer length of ducting and proper placement at the bottom of the space (Figure 6) shows more complete ventilation.

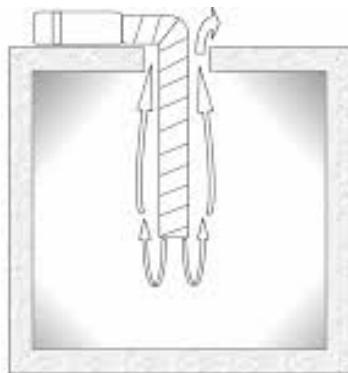

Figure 5: Shows the chimney effect that results in incomplete ventilation of the space because of improper ducting length and placement.

Source: [www.tools.niehs.nih.gov](http://www.tools.niehs.nih.gov)

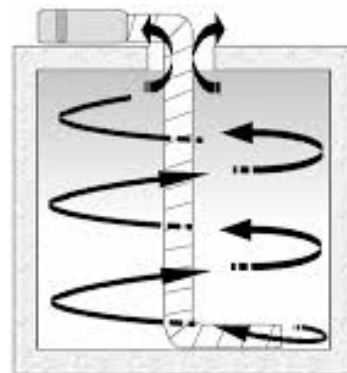

Figure 6: Shows more complete ventilation in space with proper ducting length and placement.

Source: [www.tools.niehs.nih.gov](http://www.tools.niehs.nih.gov)

### Prevent re-circulation of exhaust air

To prevent re-circulation of exhaust air in a confined space, position the air intake of the blower away from any contaminated source. This includes facing the air intake away from the opening of the confined space (Figure 7 and 8).

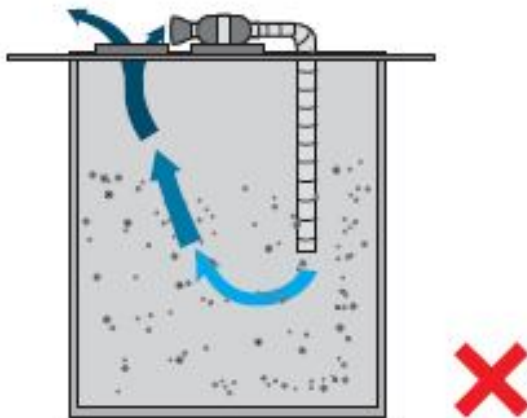

Figure 7: Blower intake in this position is re-circulating exhausted air from the space back into the space.  
Source: [www.ehsdb.com](http://www.ehsdb.com)

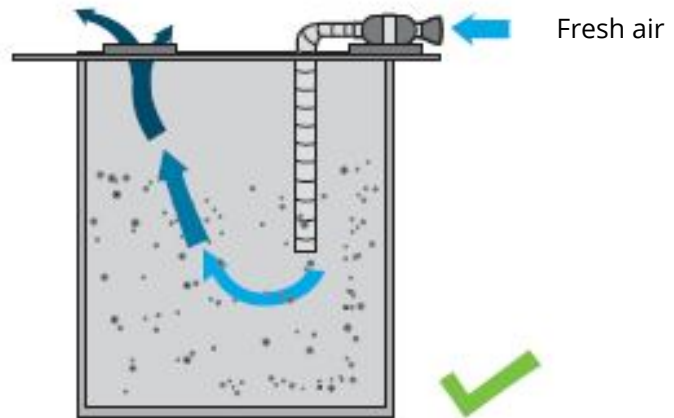

Figure 8: Blower intake in this position is drawing fresh air into the space.  
Source: [www.ehsdb.com](http://www.ehsdb.com)

### Deep confined spaces

For a deep confined space, fresh air is blown into the bottom of the space, and the contaminated air is exhausted near the top (Figure 9).



Figure 9: Blower positioned at the bottom of the space is blowing fresh air into the space and exhausting contaminants out the top opening.  
Source: [www.ehsdb.com](http://www.ehsdb.com)

### Long confined spaces

For a long confined space, fresh air is blown in at one end of the space and contaminated air is exhausted at the other end. If necessary, use a series of fans (do not connect them) to move air through long distances (Figure 10).

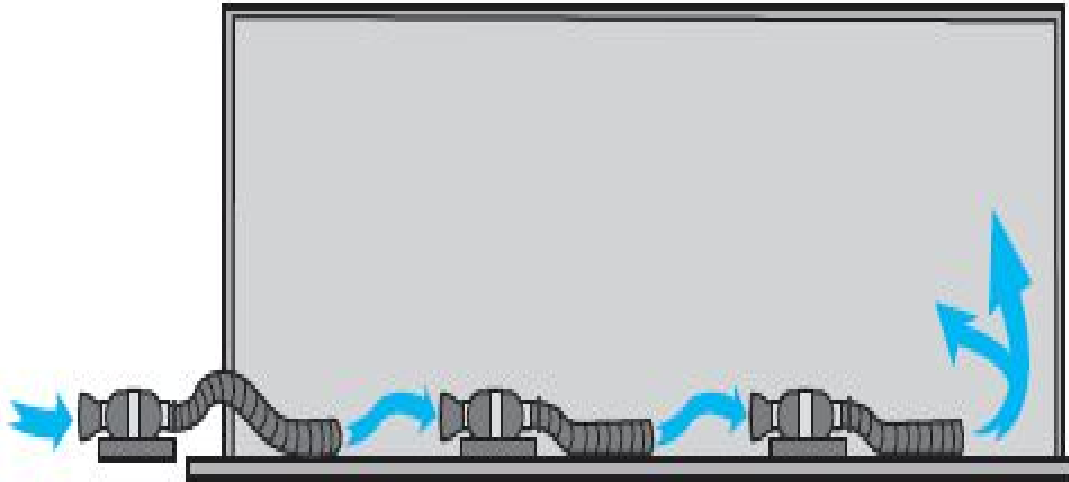

Figure 10: Blower positioned at the bottom of the space is blowing fresh air into the space. Other blowers are positioned in series to move air, ventilate the space, and exhaust contaminants out an opening at the other end.

Source: [www.ehsdb.com](http://www.ehsdb.com)

### Push-pull ventilation - using forced air and exhaust air ventilation together

A push-pull system uses a combination of both forced ventilation and exhaust ventilation to introduce fresh air into the space while exhausting contaminants (Figure 11).

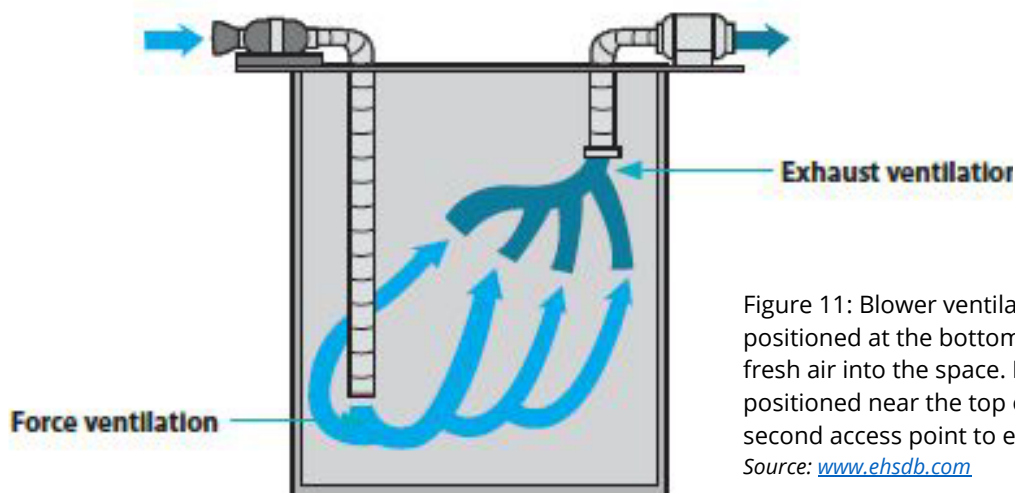

Figure 11: Blower ventilation duct is positioned at the bottom of the space blowing fresh air into the space. Exhaust blower duct is positioned near the top of the space at a second access point to exhaust contaminants.

Source: [www.ehsdb.com](http://www.ehsdb.com)



A welding operation below is using fresh air supply and local exhaust ventilation close to the work area in the confined space (Figure 12). The local exhaust system should be evaluated to ensure the system has been designed for the removal of the contaminants. Specific recommendations based on best practices include:

- The capture velocity at the task that requires local exhaust ventilation should be at least 100 fpm.
- The exhaust duct should not be more than 1.5 duct diameters in distance away from the work.
- The exhaust duct should be placed so it does not draw contaminants across the workers breathing zone.

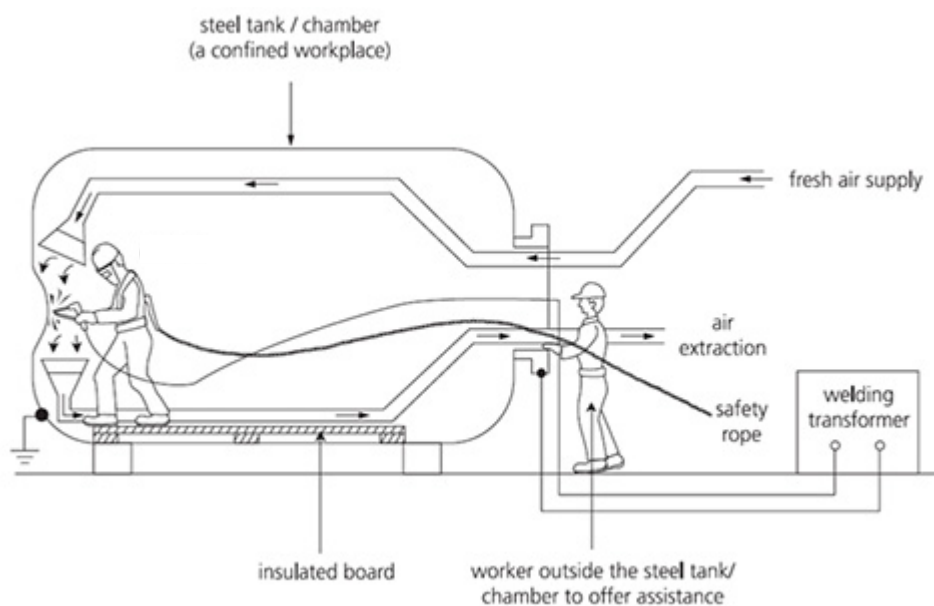
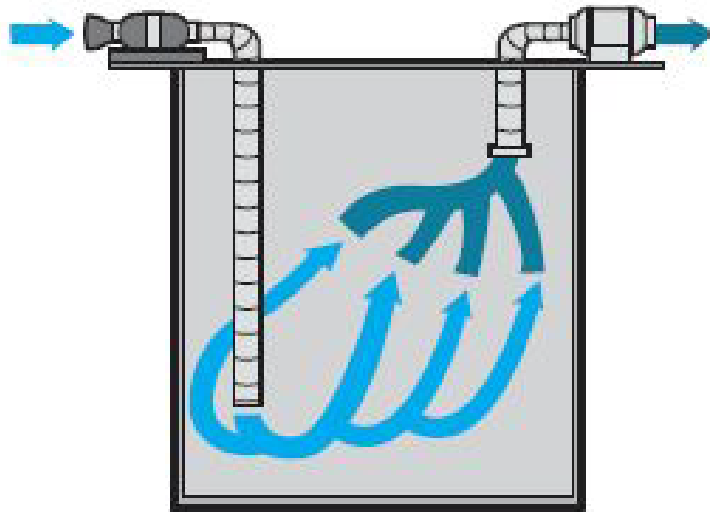

Figure 12: Fresh air is blown into the space through ventilation ducting positioned over the welder's work area. Welding fumes are captured below the work area by a separate ducting system to exhaust fumes out of the space. Source: [www.adorwelding.com](http://www.adorwelding.com)

### Removing lighter-than-air contaminants

To remove lighter-than-air contaminants from a confined space that has two openings at the top of the space, use a blower and ducting to introduce fresh air to the bottom of the space. Place an exhaust fan at the other opening to exhaust the contaminated air from the top (Figure 13).





Methane:	0.55	<i>Lighter than air gases</i>  
Ammonia:	0.59	
Carbon Monoxide:	0.96	
Nitrogen:	0.97	
Air:	1.0	
Hydrogen Sulfide:	1.2	<i>Heavier than air gases</i>
Carbon Dioxide:	1.5	
Gasoline:	3- 4	
Jet Fuel, JP-8:	4.7	

Figure 13: Blower ventilation duct is positioned at the bottom of the space blowing fresh air into the space. Exhaust blower duct is positioned near the top of the space at a second access point to exhaust contaminants near the top of the space. Source: [www.ehsdb.com](http://www.ehsdb.com)

### Removing heavier-than-air contaminants

To remove heavier-than-air contaminants from a confined space that has two openings at the top of the space, use an exhaust fan and ducting to capture the low-lying contaminants. Place a blower at the other opening to provide fresh air to the space (Figure 14).

When painting, the solvents are generally heavier than air and more effectively removed by placing the exhaust ducting below the operation.

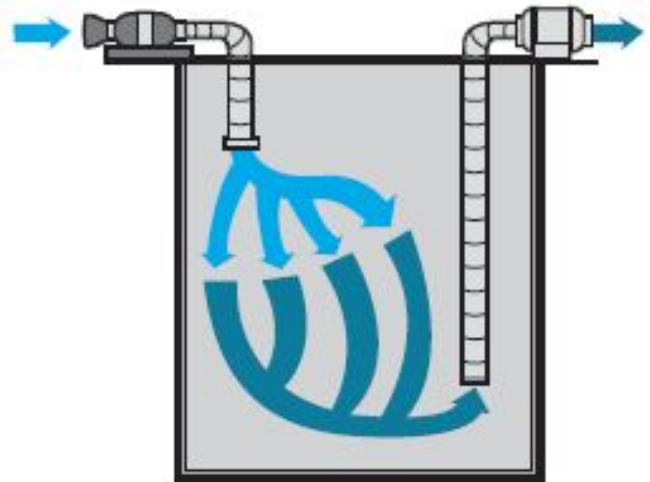

Figure 14: Exhaust ventilation duct is positioned at the bottom of the space to exhaust low-lying contaminants from the space. Forced air ventilation blower duct is positioned near the top of the space provides fresh air to the space. Source: [www.ehsdb.com](http://www.ehsdb.com)

### Two access points with one blower

If two openings into a space are available (Figure 15), opening the second access will greatly enhance air circulation within the space.

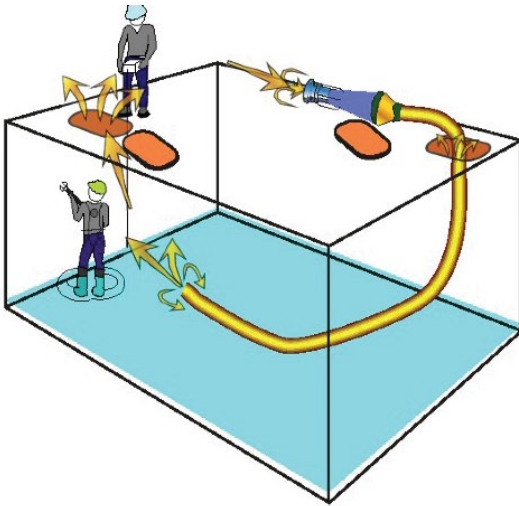

Figure 15: Shows enhanced method of supplied ventilation (forced air) when two accesses are available.

Source: ([www.osha.gov](http://www.osha.gov)) Edward J. Willwerth, Atlantic Environmental & Marine Services

Using exhaust ventilation and placing the ducting where contaminants are released into the air by the operation captures the generated contaminants and greatly reduces exposure to workers in a space. Figure 16 shows this method with one access open, while Figure 17 shows the same method with two access openings, allowing enhanced removal of contaminants.

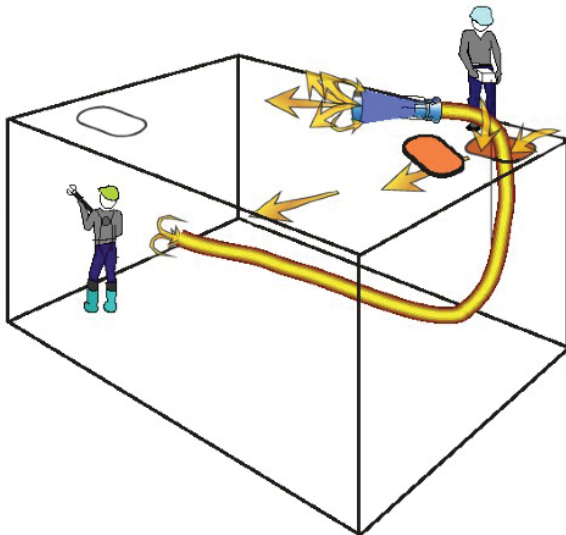

Figure 16: Showing an exhaust duct placed in the area where it will capture contaminants, reducing worker exposure.

Source: ([www.osha.gov](http://www.osha.gov)) Edward J. Willwerth, Atlantic Environmental & Marine Services

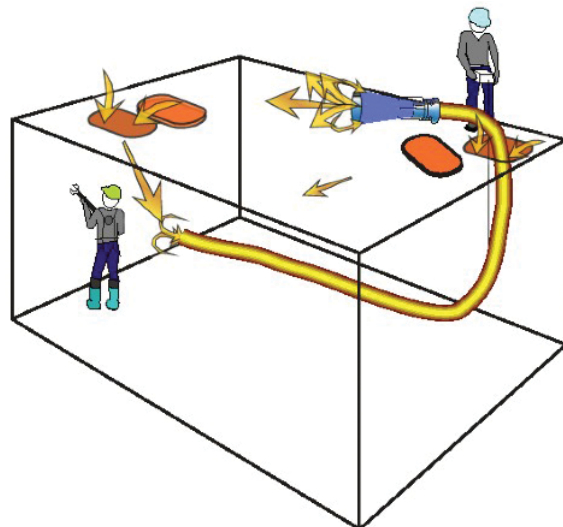

Figure 17: Showing enhanced ventilation by opening a second access in addition to exhaust duct placement to capture contaminants.

Source: ([www.osha.gov](http://www.osha.gov)) Edward J. Willwerth, Atlantic Environmental & Marine Services

### Local exhaust near worker with one blower

During welding operations, contaminants generated will be hot and tend to rise. Placing an exhaust duct over the welding operation will capture and remove the greatest amount of contaminants (Figure 18).

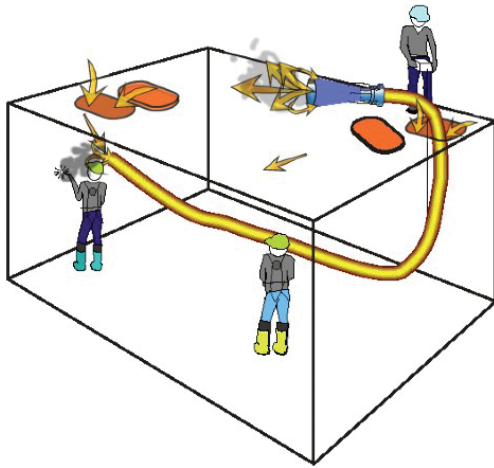

Figure 18: Showing the appropriate placement of ducting to remove welding fumes.

Source: ([www.osha.gov](http://www.osha.gov)) Edward J. Willwerth, Atlantic Environmental & Marine Services

### Resources

Occupational Safety and Health Administration (OSHA Pub. 3639-04 2013) [Ventilation in Shipyard Employment](#)

Environmental, Health & Safety Data Base website ([www.ehsdb.com](http://www.ehsdb.com))

National Institute of Health [Lesson 6: Confined Space Preparation](#)

Ador Welding website ([www.adorwelding.com](http://www.adorwelding.com))

[Back to Top](#)

## Appendix H: Permit-Required Confined Space (PRCS) Rescue Service Evaluation Form

A fillable Confined Space Rescue Service Evaluation Form can be accessed [here](#).

See next page.

[Back to Top](#)

## Permit-Required Confined Space (PRCS) Rescue Service Evaluation

University of Washington department completing this evaluation:		
UW employee completing evaluation:		Date:
Rescue Service Under Evaluation:		Contact Information:
All Permit Required Confined Spaces under Rescue Services review:		
Description of all hazards in the listed spaces:		
Permit-Required Confined Space Information (UW completes)		
1	Does PRCS or the work being performed in the PRCS contain or have the potential to create an Immediately Dangerous to Life or Health (IDLH) atmosphere? <i>If "yes," an on-site rescue service may be required during the entry.</i>	<input type="checkbox"/> Yes <input type="checkbox"/> No
2	Are the PRCS entrances large enough or readily accessible to enter by personnel with typical rescue gear (SCBA, stretcher basket, etc.)?	<input type="checkbox"/> Yes <input type="checkbox"/> No
3	Can the department provide the selected rescue team access to the spaces when needed for training?	<input type="checkbox"/> Yes <input type="checkbox"/> No
Initial Evaluation (Rescue Service completes)		
1	Does your rescue service provide on-call and/or on-site entry rescue?	<input type="checkbox"/> On-call <input type="checkbox"/> On-site
2	If on-call, what is the rescue service approximate response time to the UW PRCSs?	
3	If the rescue service becomes unavailable during an entry, can they notify UW so that attendant can stop the entry?	<input type="checkbox"/> Yes <input type="checkbox"/> No
4	Does the rescue service have adequate equipment to conduct a rescue in all UW PRCSs listed?	<input type="checkbox"/> Yes <input type="checkbox"/> No
5	Is the rescue service familiar with the hazards in the UW PRCSs?	<input type="checkbox"/> Yes <input type="checkbox"/> No
6	Does the rescue service conduct annual practice sessions where dummies, manikins, or actual persons are removed from similar spaces?	<input type="checkbox"/> Yes <input type="checkbox"/> No
7	Does the rescue service have established procedures to rescue entrants?	<input type="checkbox"/> Yes <input type="checkbox"/> No
8	Does the rescue service have a plan for every UW PRCS listed?	<input type="checkbox"/> Yes <input type="checkbox"/> No
9	Are all team members knowledgeable in first aid and CPR and is at least one team member currently certified in first aid and CPR?	<input type="checkbox"/> Yes <input type="checkbox"/> No
Other questions that may apply		
10	If needed, can the rescue service test the atmosphere to identify acceptable entry conditions?	<input type="checkbox"/> Yes <input type="checkbox"/> No
11	Can the rescue service rescue injured persons from PRCS with any of the following?	
	• Limited size opening (less than 24 inches) in diameter?	<input type="checkbox"/> Yes <input type="checkbox"/> No
	• Limited internal space?	<input type="checkbox"/> Yes <input type="checkbox"/> No
	• Internal obstacles or hazards?	<input type="checkbox"/> Yes <input type="checkbox"/> No
12	If needed, can the rescue service perform an elevated (high angle) rescue?	<input type="checkbox"/> Yes <input type="checkbox"/> No

Item #	If "No" checked, add comments

## Appendix I: Equipment for Confined Space Entry and Rescue

Selection and use of proper equipment and systems for confined space entry and rescue is critical to the health and safety of all persons involved. This appendix presents variations of systems that may be appropriate for the different types of confined spaces. Select equipment that has adequate clearance for activities to be conducted, allows personnel to enter and exit, and has the potential for rescue activities. The basic functions systems need to provide include:

- Lowering and raising Entrants, tools and materials into and out of the space
- Fall protection for Entrants and Attendants
- Emergency rescue of Entrants from the space during non-entry rescue

The relationship between fall protection and non-entry rescue equipment is presented in this section. Scenarios are illustrated showing when specific equipment may be used for fall protection only, for non-entry rescue only, and for both fall protection and non-entry rescue. The configurations of rescue systems may differ significantly; but, if properly selected and configured, these systems can also serve as fall protection in confined spaces where fall hazards exist.

### **Anchorage System**

A tripod (Figure 19) is a typical anchorage system used for entries into confined spaces with a vertical entrance. Properly equipped, it can meet the requirements for:

1. Lowering and raising Entrants, tools and materials
2. Fall protection
3. Rescue

The tripod may have several anchor points in various locations. It is critical to know the capacity of each of the anchor points and the overall system, and the limits of use for the anchor points. For example, a specific anchor may not be rated for fall protection. Read the instruction manual or contact the manufacturer. Many tripod systems are designed to be used by one person, or one person at a time. If an Attendant or others outside the space need to tie off for fall protection, a tripod anchor may not have the capacity, so they would need to use an anchor separate from the tripod. Using a tripod system may be limited by the size or configuration of the space opening.

Alternatives to tripods are davit arm (Figure 20) and davit post systems (Figure 21). Davit systems (or the system base) can be installed permanently near a confined space area or they can be attached to a portable base. Davit systems can be equipped with the same devices as tripods. Some advantages over tripod systems is that davit systems do not cover the entire entrance to the space, and some are equipped with guardrail systems for the space entrance.

All types of anchorage systems can be set up with the following types of devices and configurations to meet the basic requirements:

1. Bi-directional winch (Figure 22)
2. 3-way self-retracting lifeline (Figure 23)

3. Combination winch and 3-way self-retracting lifeline (Figure 24)

For examples of harnesses and specific connectors, refer to Appendix E in [UW Fall Protection Program Manual](#).

[Back to Top](#)



## 3M™ DBI-SALA® Tripod Systems

The 3M™ DBI-SALA® Confined Space Tripod is constructed of tubular lightweight aluminum and a rugged steel head assembly. These tripods are extremely lightweight and portable, easily set up by one worker and can be transported from one location to another. Designed for confined space entry and emergency rescue applications, they can accommodate a variety of winches and fall arrest devices. 3M tripods are also loaded with features such as spring-loaded locking legs, simple detent pin style adjustment, quick-mount mechanical device brackets, safety chains to prevent movement, and safety shoes that incorporate a rubber sole for flat surfaces and spiked edges for slippery surfaces.



### 1 Integrated Re-Directional Pulleys

Integrated pulleys are top mounted for smooth operation.

### 2 Spring-Loaded Tripod Legs

Spring-loaded leg assemblies snap securely into position when fully deployed, eliminating the need for pins.

### 3 5,000 lb. (22 kN) Rated Anchor Points

Two integrated 5,000 lb. (22 kN) anchor points provide many versatile and robust anchoring options.

### 4 Safety & Inspection Manager Capable

Equipped with a RFID tag to streamline your safety and asset management.

### 5 Accessories

A multitude of accessories provides the options and versatility needed to tackle unique confined space challenges.

### 6 Connecting Devices

Can support up to four connecting devices (winches/SRLs) for complete flexibility

### 7 Anodized Aluminum Construction

Lightweight yet durable construction for ease of use and longevity.

### 8 Telescopic Legs

Provide integrated means of leveling and adjustment. Legs are securely locked with steel detent pins.

### 9 Safety Chains

Provides added support and strength for demanding confined space applications.

### 10 Foot Pads

Pivoting footpads have built in sharp points for digging into soft and/or uneven terrain.



Figure 19: A tripod system prepared to provide fall protection and non-entry rescue. Designed to be mobile and placed over the top of a confined space, such as over a manhole entrance (3M Company [www.3m.com](http://www.3m.com)).

## 3M™ DBI-SALA® Davit Arm System Components

Variable offset davits are designed for use where multiple offset masts are required. The variable offset masts may be equipped with front mounted and/or back mounted winches or Self-Retracting Lifelines (SRLs) and feature an anchor point rated up to 5,000 lbs. (22 kN). For applications with overhead clearance restrictions, the adjustable height of the variable offset masts can eliminate the need for custom length masts and mast extensions. Quick-connect/release pins allow for fast and easy setup, dismantle and transport.

### 1 Winch

Davits can be equipped with both primary and secondary (back-up) mechanical devices for added flexibility. Retrieval winches can be used in conjunction with a retrieval SRL or fall protection system to raise and lower personnel and equipment.

### 2 Quick-mounting brackets

Simple detent-style winch mounting brackets make installation fast and efficient. (See page 18 for options.)

### 3 Retrieval SRL

Retrieval SRLs offer fall protection as well as emergency retrieval for non-entry rescue.

### 4 Lower mast extensions

Allow the user to adjust the overall anchorage height of the system.

### 5 Base options

Several portable and fixed base options are available for complete versatility.

### 6 Variable offset mast

Adjustable length of davit ensures lifelines are always centered over confined space.

### 7 Built-in pulleys

Route lifelines of two mechanical devices for smooth, efficient operation.

### 8 Fall arrest anchorage

Up to a 5,000 lb. (22 kN) rated anchor point for fall arrest device.

### 9 Adjustable height

Eliminates the need for custom length masts and extensions.



61

Figure 20: A davit arm prepared to provide fall protection and non-entry rescue. Designed to be mobile or permanently installed and can support vertical or horizontal entries (3M Company [www.3m.com](http://www.3m.com)).



Figure 21: Three persons may be tied off to the post system for fall arrest at any given time. Adding extension or davit arm assemblies to the post reduces the capacity (Miller DuraHoist Portable Fall Arrest Post and Extension Post [www.safety.honeywell.com](http://www.safety.honeywell.com)).

### Bi-directional Winch

Attached to the anchorage system, the basic bi-directional winch is manually operated and comes in varying lengths and cable materials. It can be used to lower and raise Entrants, attached to their full-body harness, and materials, and conduct non-entry rescue. It does not provide fall protection. Winches are weight rated and designed to support personnel only (“man-rated”), materials only, or both. For lifting long distances, a power driven man-rated winch with a slip clutch can be used.



Figure 22: Bi-directional winch

### 3-way Self-Retracting Lifeline (SRL)

A 3-way SRL can be attached to the anchorage system support arm or leg (as in Figure 19 and 20) or attached to an anchor point on the system. The cable from the SRL is attached to the Entrant’s full body harness. Once anchored, the SRL lifeline extends and retracts automatically, letting the Entrant move within the space while keeping lifeline tension. If an Entrant falls in the space, a speed-sensing brake mechanism activates, arresting the fall. The SRL can be used for raising, lowering and rescue, but it is not recommended for routine use. It is typically used as a backup to a primary method of raising and lowering such as a basic winch or a ladder. Standard SRL’s have fall arrest and self-retracting lifeline capabilities.



Figure 23: Self-Retracting Lifeline



Figure 24: Winch and Self-Retracting Lifeline

### Combination Winch and 3-way Self-Retracting Lifeline

This is the safest system setup that provides extra protection and support (Figure 24). This type of non-entry rescue setup is required by regulations when Entrants need to be continuously raised and lowered into a confined space. This requires that two lines be attached to the Entrant. It is especially effective for rescue of Entrants in tanks, vaults and storage bins.

### Fall Protection Considerations

Attendants and Entrants may both be exposed to fall hazards during a confined space entry. Fall hazards are defined by fall protection and walking-working surfaces regulations. All fall hazards must be eliminated or controlled; consult the [UW Fall Protection Program Manual](#) for more information. Methods of fall hazard elimination include passive fall protection and fall restraint systems. In some situations, the only way to control a fall hazard is with a personal fall arrest system.

Note that a fall hazard alone would not cause a confined space to become a permit-required confined space. If all fall hazards are eliminated or controlled, the space may be able to be entered using Alternative Methods.

### Attendant Fall Protection

The Attendant's fall hazards must always be addressed and eliminated outside of a confined space during entry. Passive fall protection, such as guardrails, are the preferred method so the attendant can successfully perform their duties. If the attendant is using a fall restraint as fall protection, the attendant must be tied off to a permanent or temporary anchor that can withstand 5,000 lb. of force, outside of the confined space. It is important to note that tripod capacity is usually limited to one person.



Figure 25: Attendant tied off for fall protection

### Attendant Fall Protection Scenario

In Figure 25, an attendant tied off for fall restraint to an external anchor to prevent falling into the space opening. Guardrails could not be installed at the opening and the tripod system was designed to support only one person, the Entrant, in this case.

### Entrant Fall Protection during Entry

The Entrant's fall hazards must be addressed with fall protection. Fall hazards may exist upon entry into the confined space (e.g., a ladder exceeding 24 feet) or inside the confined space, such as an unguarded ledge with a drop greater than 4 feet. Fall protection equipment must meet the UW Fall Protection program requirements. All anchor points on tripods, davit arms, or elsewhere must withstand 5,000 lb. of force. See Figure 26 showing permanent anchors on the wall at a confined space entry opening. A self-retracting lifeline (SRL) is attached to one anchor.



Figure 26: Permanently mounted anchor at confined space entry. SRL is backup fall protection to fixed ladder. (Diversified Fall Protection Co. [www.fallprotect.com](http://www.fallprotect.com))



Figure 27: Entry to manhole. Note manhole steps start some distance from opening. Fall protection is critical upon entry.

Figure 27 illustrates the importance of fall protection when entering a manhole. Manhole steps, common in manholes, may start several feet below the entrance. The Entrant's harness and lifeline needs to be securely connected to a SRL and 5,000 lb. tripod anchorage or equivalent outside the space. The condition of the rungs must be inspected periodically for corrosion.



Entering spaces through roof hatches and floor access doors with fixed ladders may also present fall hazards. Attaching a temporary safety post to the top ladder rungs is another approach to fall protection (Figure 28). The person attaching the safety post may need to be attached to a fall restraint system. Permanent safety posts that fold down when the hatch is closed are also available.

Figure 28: Entry through roof hatch to fixed ladder. A safety post is attached to top ladder rungs for fall protection. (LadderUp Safety Post [www.bilco.com](http://www.bilco.com))

### Ladder Entry Scenario

In Figure 29, an Entrant is entering a confined space on a fixed ladder greater than 24 feet long, which does not have a ladder safety device. The entrant is connected to a tripod setup with a retrieval self-retracting lifeline (SRL) and wearing a full body harness. The ladder is the primary method of fall protection and the retrieval SRL is secondary fall protection. In the event of a fall off the ladder, the SRL will serve as fall arrest, breaking the fall, and the Entrant can grab the ladder, continue on down or exit the space using the ladder.

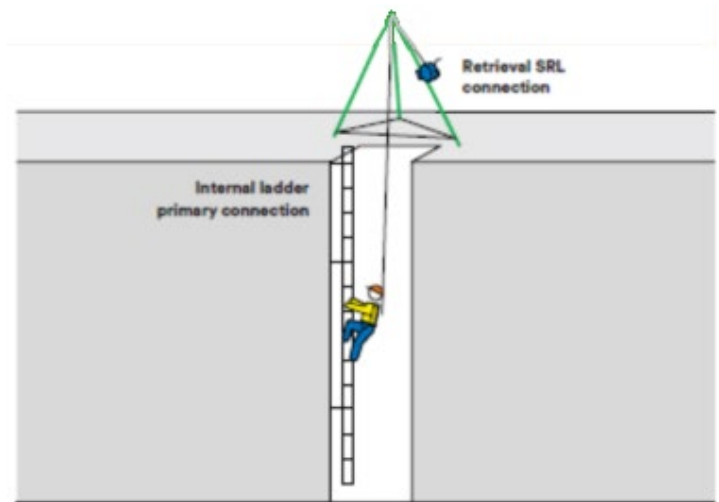

Figure 29: Entrant connected to SRL for fall protection

### Fall Protection inside the Confined Space

Where fall hazards exist within a permit-required confined space, Entrants must be attached to individual retrieval systems anchored outside the space, if possible. Anchors must be strong enough to withstand 5,000 lb. of force expected from a fall. Where possible, these systems should limit the ability of Entrants to approach unprotected edges, in effect becoming fall restraint rather than fall arrest.

Work activities inside the space may require fall protection. If fall hazards cannot be guarded or eliminated, a permanent or temporary anchorage system must be installed for a worker to tie off to in appropriate locations for fall restraint. Activities could include working at heights, scaffold assembly, or working near a ledge. Anchorage points must withstand 5,000 lb. of force. An Entrant may enter the space connected to an exterior anchor and retrieval SRL, then disconnect from the SRL, and connect to a separate line connected to an anchor inside the space to do work that may have fall hazards. When the work is done they would disconnect from the space anchor and reconnect to the retrieval SRL.

### *Scaffold in Confined Space Scenario*

An Entrant needs to do work at an elevated level inside a confined space. There is no safe access to the location and using a ladder would be unsafe. The plan is for Entrant(s) to enter the space, receive light aluminum scaffolding parts from coworkers outside the space, and assemble the scaffold inside the space. During assembly, the Entrant ties off to a 5,000 lb. anchor located above the work area for fall protection. When assembled, the scaffold guardrails provide fall protection for the Entrant while doing the work (Figure 30).



Figure 30: Work from scaffold in confined space [www.quadcitysafety.com](http://www.quadcitysafety.com)

### **Non-Entry Rescue**

Even if no fall hazard exists within the space, non-entry rescue equipment is required to be set up prior to entry into permit-required confined spaces with a vertical depth greater than 5 feet. Mechanical retrieval equipment must be used with a system to prevent the Entrant from falling during entry.

In horizontal spaces, retrieval equipment could be a rope or cable system attached to the Entrant's harness (or to wristlets, anklets, etc., if appropriate). Retrieval systems must be anchored to a 5,000 lb. anchor outside the space to prevent the system from being accidentally pulled into the space. The traditional tripod rescue system will not work for the side loads a horizontal rescue would require. Specialized side-entry rescue systems that attach to the flange of a round entry point are an option. A system can also be assembled (see Figure 31) using a temporary anchor strap attached to a beam or other structural steel anchor point near the entry to the space. A self-retracting lifeline (SRL) rescue winch is attached to the anchor with a carabiner. The cable in the SRL is attached to the Entrant's harness. See the [UW Fall Protection Program Manual](#) for more information about anchorage systems



Figure 31: Horizontal confined space lifeline rescue kit. [www.majorsafety.com](http://www.majorsafety.com)



### Horizontal Space Rescue Scenario

An Entrant needs to enter a long confined space with a side entry to perform inspections and maintenance of electrical systems in the space. The horizontal confined space (Figure 32) requires a horizontal, non-entry rescue system. An anchorage post system was installed outside the space opening that could sustain a force of 5,000 lb. An SRL rescue winch was securely attached to the post. The SRL cable was attached to the D-ring on the back of the Entrant's harness. Since there are no pulleys used in retrieval systems for horizontal entries, the Attendant is pulling the full weight of the Entrant upon rescue.

If a full-body harness is not safe or possible to use, consider using rescue wristlets for rescue (Figure 33).

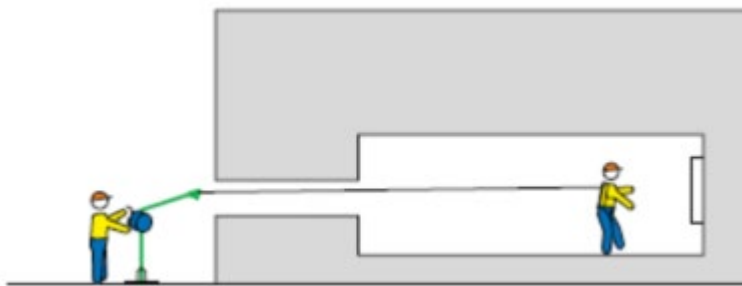

Figure 32: Horizontal non-entry rescue.



Figure 33: Rescue wristlets  
[www.frenchcreekproduction.com](http://www.frenchcreekproduction.com)

### Fall Protection and Non-Entry Rescue

In vertically configured spaces without a ladder, stairs or other self-assisted entry, retrieval systems should have the capability of both lowering and raising personnel for entering and exiting the space. The retrieval system must include a primary system and a backup system appropriately anchored outside the space (see Figure 34). Backup systems should be anchored independent of the primary system so that protection is provided if the primary system fails.

#### Vertical Space Entry without Ladder Scenario

In Figure 34 a tripod and winch are used to lower an Entrant into a vertical entry space with no internal fixed ladder. The backup system on a different anchor on the tripod is a self-retracting lifeline (SRL) equipped with a retrieval winch. It provides fall protection and backup rescue. If the primary winch or cable fails, the SRL arrests the fall and the Entrant can be rescued with the retrieval winch on the SRL.

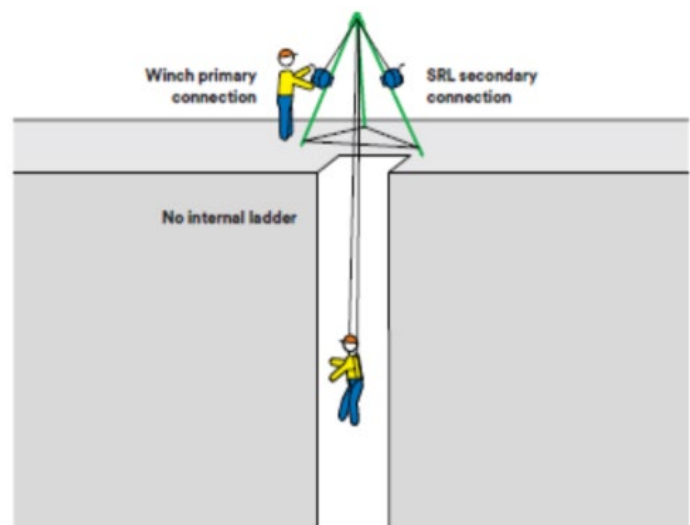

Figure 34: Vertical entry with tripod anchorage

[Back to Top](#)